

prostoria

10



Prostoria 10 celebrates 10 years of our love of design and furniture making.

Contents

Introduction	5
Sustainability	8
Heritage	20
Revisiting Architecture	28

Sofas, Sofabeds and Accessories	118
Chairs and Tables	264
Outdoor	396
Designers	440

1

2

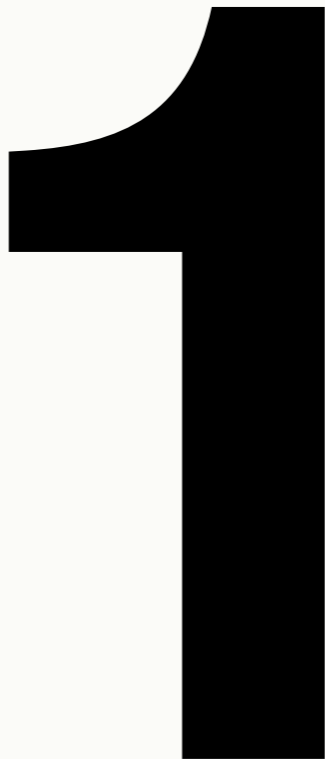

business. It is also an expression of
at is unique, and which fills a room
. Just as we were approaching
orld suddenly slowed down in a way
. The pandemic threatened both
ry, forcing all of us back into our
at Prostoria found ourselves.
· factory, as this was the place we
down, our craftsmen kept their tools
esigners and engineers carried on
cision taken ten years ago to base
rters in Croatia turned out to have
e time to enjoy exploring materials
nuances of craftsmanship involved
would want to spend the rest of
shifted the dynamics of home and
re the focal points of a new search
nges in function and behaviour
t of new meanings. In this new and
aluated relationships with their
ver their daily clutter. In a sense, all
le, re-invent ourselves, and develop
sonal surroundings and the natural
d many business premises around
ore and more individuals are coming
omes. This shift reflects a deep trust
degree of comfort and vitality they
iversary, this opportunity to help
ething we greatly appreciate.
used this period to reflect on our
e very essence. All the better for you

Prostoria is not just a family-owned business. It is also an expression of our passion for creating furniture that is unique, and which fills a room with a palpable sense of well-being. Just as we were approaching Prostoria's tenth anniversary, the world suddenly slowed down in a way that none of us could have foreseen. The pandemic threatened both global health and the global economy, forcing all of us back into our homes. Which is exactly where we at Prostoria found ourselves.

We cocooned ourselves in our factory, as this was the place we considered home. Even during lockdown, our craftsmen kept their tools and machines working, while our designers and engineers carried on developing new prototypes. The decision taken ten years ago to base furniture production at our headquarters in Croatia turned out to have been the right one. It has given us the time to enjoy exploring materials and technology, and to perfect the nuances of craftsmanship involved in creating the kind of furniture you would want to spend the rest of your life with. As the pandemic has shifted the dynamics of home and work, our home spaces have become the focal points of a new search for comfort and security. These changes in function and behaviour have given these spaces a whole set of new meanings. In this new and unfamiliar reality, people have re-evaluated relationships with their surroundings and cast a fresh eye over their daily clutter. In a sense, all of us have been forced to grow a little, re-invent ourselves, and develop a deeper awareness of both our personal surroundings and the natural environment. Prostoria has furnished many business premises around the world, but in this new context, more and more individuals are coming to us in search of furniture for their homes. This shift reflects a deep trust in our products and the long-lasting degree of comfort and vitality they bring. As we celebrate our tenth anniversary, this opportunity to help reshape lives in a new reality is something we greatly appreciate.

As have many others, we have used this period to reflect on our aims and strip ourselves down to the very essence. All the better for you to see just what we are made of.

Materials, Sustainability and Heritage 6—25

Written in our Core



A good piece of furniture will always help people reconnect with themselves. Especially when it's made from natural materials. Furniture, when well designed and made with a bit of love, helps us feel anchored in the everyday in a world increasingly absorbed in digital communication. Natural materials inspire particularly strong feelings, perfectly designed to withstand life's changing challenges and apt to become more beautiful as they age. When we take something from nature, we feel obliged to give something in return. At Prostoria, we give back by creating responsible furniture whose functionality, durability and comfort result in timeless aesthetics. Our factory operates as a research lab where sustainability is embedded in the design process, and where we use top-quality materials from prototype development right through to full scale production.

Our dedication to quality is reflected in our decision to manufacture all types of furniture in-house, thereby ensuring adherence to high standards. By sourcing solid wood locally, and transporting our furniture directly from our factory with vehicles loaded at full capacity, we reduce our CO₂ emissions. Sustainability is a deep-seated way of thinking, written in our core.

All wood waste, such as sawdust, is sold on to the wood-pellet industry, while small wood residues are sold locally as firewood. Metal waste is sent to a foundry where it is melted down and prepared for reuse. Waste that is hazardous to the environment, such as wastewater, glue and packaging residue, is managed by outsourced specialised companies.

Prostoria holds the FSC 100% (Chain of Custody) certificate, the ISO 9001:2015 Quality Management System Certificate and adheres to the ISO 14001:2015 Environmental Management System.

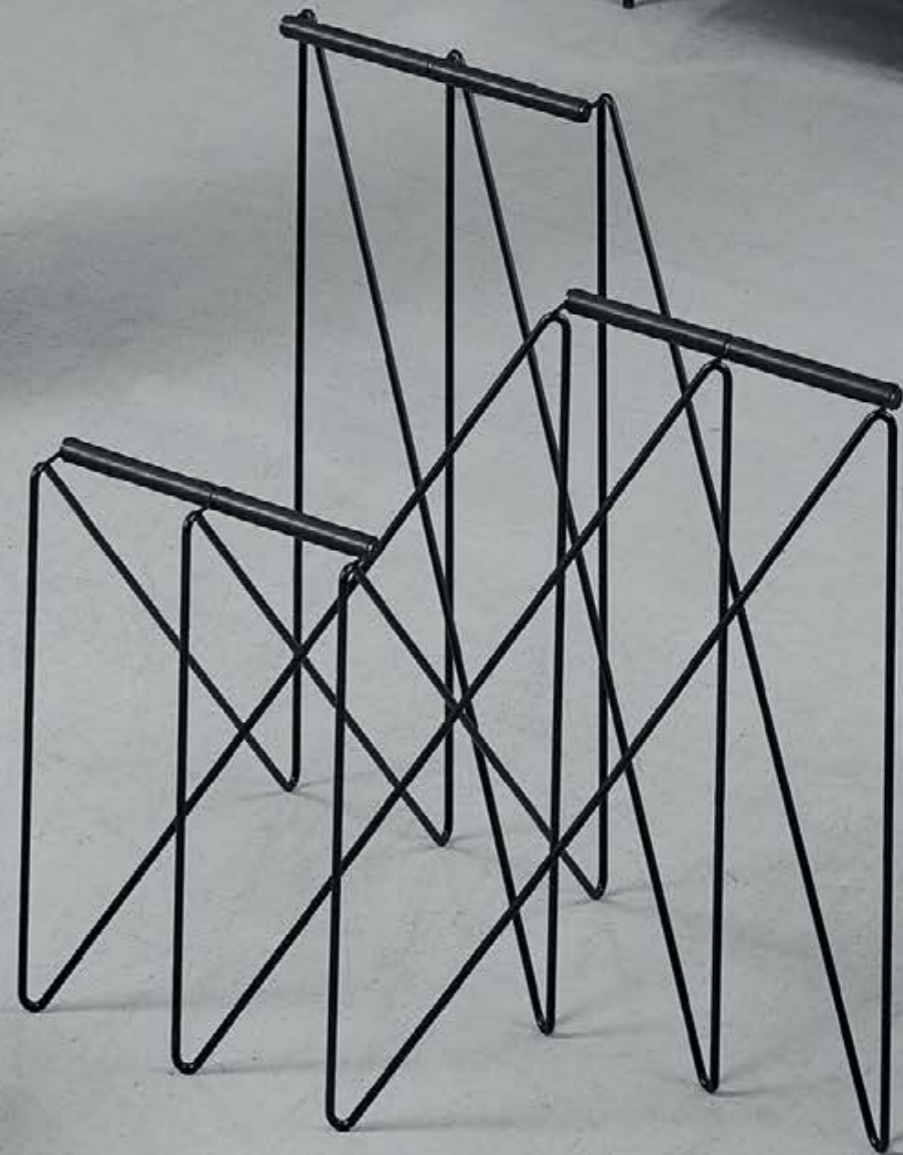
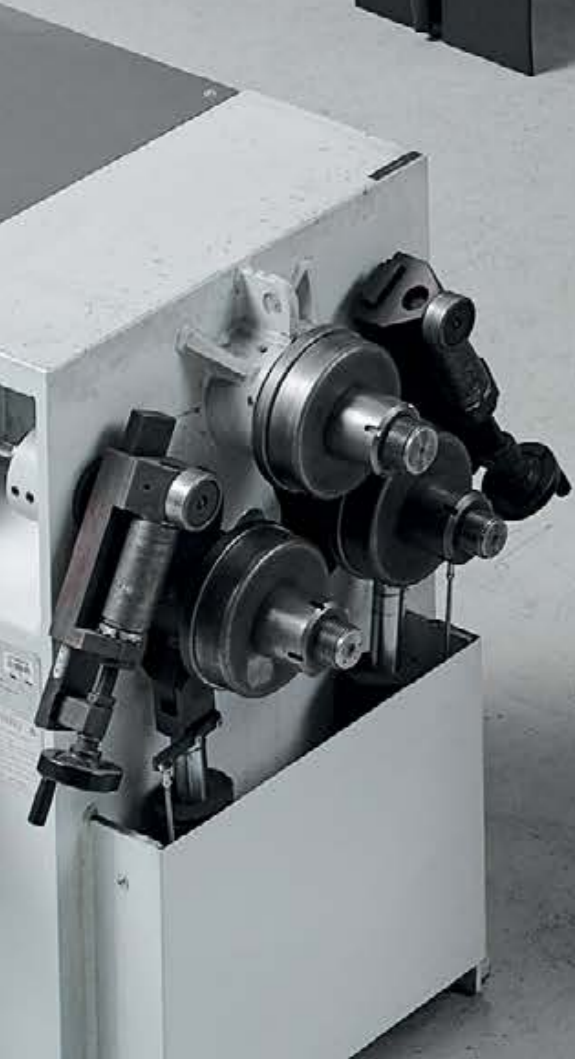
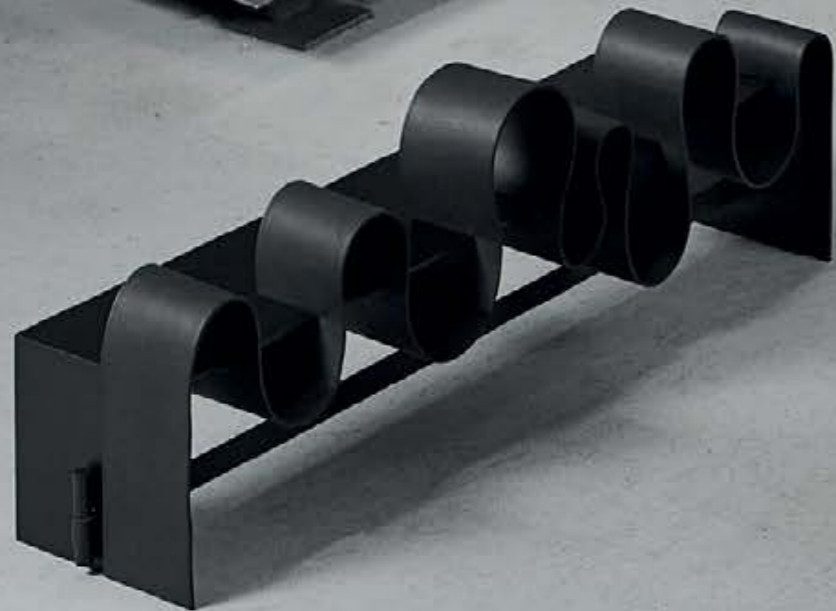

Wood

Croatia is home to dense forests that make up 49.3% of the country's total area. It is from these that we source our wood: walnut, ash, pine, beech and Slavonian oak. We also import other types of wood including teak, iroko and larch from their countries of origin. We hold the FSC 100% (Chain of Custody) certificate for the purchase of wood. Our carpentry is more than a production facility; it is a care facility for wood treated in order to ensure the excellence of the product. The whole timber-processing cycle is controlled, from the cutting and sawing to the final production phase. After leaving our sawmill, timber is dried naturally on our premises and transported to a drying chamber where the process is finished off in strictly controlled conditions. Finally, the timber is placed in a dry warehouse for selection and production.



Textile

We have embraced the use of natural materials as the core of our design process since the very beginning. Eighty-five per cent of the fabrics used in our product lines is of natural origin. Over the years, we have selected partners who are dedicated to the manufacture of high-end textiles from natural wool and cotton fibres. Original features are enhanced through their designs and their use of environmentally friendly technologies. Many of these partners are not only leaders in the textile industry but also in their innovative approach to sustainability.



Leather

In our upholstery department, working with leather is an art; we treat this exquisite material as haute couture. For example, sturdy leather is an integral part of the Strain chair's construction, while the supplest leather is used for the Cloud sofa, further enhancing its lush comfort. During the design process, we select only the best leathers, which we source from trusted EU partners who are in full compliance with the regulations pertaining to animal welfare. All of our leather manufacturing partners use life-cycle assessments and are Blue Angel certified.



Metal

Each of our product designs has led us to employ a high degree of innovation in the production process and to invest heavily in technology. The design of the metal constructions for both the Polygon and Strain easy chairs forced us to research various possibilities that metal as a material can provide, as well as the relevant manufacturing technology. Thus, we identified the need to establish our own state-of-the-art metal workshop.

The bent-metal method of construction has since become a signature design, and our metal workshop has grown into a laboratory of concept development, prototyping, tooling and bulk production. Here, engineers and master welders apply creative thinking and considerable expertise to find solutions to complex technological problems.



Foam

Ever since producing its very first sofas and sofa-beds, Prostoria has earned an outstanding reputation for its mastery of comfortable seating. The combination of various kinds of foams that interact with other materials in the furniture production process defines the volume, ergonomics and the overall experience of the furniture we produce. We only use the best quality, highly resilient polyurethane and moulded foams, all of which are recyclable. We are currently preparing to start production of moulded foam in our own factory, so that all aspects of furniture production will be concentrated under one roof. Our upholstered furniture will henceforth incorporate a moulded foam that is highly suitable for creating innovative forms, and absolute precision in design and sustainability.



Our commitment to the materials through which we explore our new designs serves as an inspiration behind the series of sculptures entitled Essence. Studio Boir designed a series of sculptures inspired by Prostoria products, reflecting our approach to the use of materials, our diverse manufacturing skills, the precision we bring to bear in our production process and, most importantly, the essence of each material that we use.

The upper side of the Leather sculpture is strung between notches on the metal base and emphasizes the essence of the material's elasticity while maintaining the stability of curved shapes. On the bottom side, the leather is part of the construction, re-affirming the material's solidity. The shape of the metal is inspired by the Shtef shelf, while the way in which the leather is fixed to the metal construction is inspired by the Strain armchair.

The Wood sculpture is inspired by the triangular shape formed by the legs of the Oblique table, multiplied into a regular grid of elements, made of different materials in different finishes. The aim is to showcase the variety of surfaces and the beauty of variations.

The Metal sculpture takes its cue from the bent bars characteristic of the Polygon low table, whose form is multiplied in a series of three identical elements. In the upper part of the sculpture, the bars are connected by a round tube lined with leather, as in the armrest of the Kontrapunkt armchair.

The Fabric sculpture presents various fabrics in a variety of colours, thickness's and textures, in which cylindrical sponge forms are upholstered, and set on a metal base inspired by the Convert sofa base. It demonstrates Prostoria's skilful approach to the manufacture of fine upholstered furniture, and our considerable expertise in textile application and sewing techniques.

The Sponge sculptural totem is inspired by the sponge form designed for Prostoria's Segment modular seating system. The three stages in the production of the sponge form are placed on a solid plywood base, while the sponge is pressed down from above by metal, and tightened with the leather belt used in the Bavul collection. This composition demonstrates the elasticity of sponge and its interaction with other materials in the design of upholstered furniture that is comfortable, functional and ergonomic.

Štof by Prostoria



At Prostoria, the pieces of fabric left over by the production process are given a second chance. Realising that these leftover fabrics are a resource, we used them as the foundation for our sub-brand Štof by Prostoria, which has its own showroom in Zagreb. Štof serves as an eloquent platform for a circular economy in which the textiles from our previous collections are recycled, and cushions are made from the leftovers. The latest Štof project involves two kinds of tote bags, designed to be made from previous Prostoria textile collections. We also support the restoration of vintage furniture, a craft revived by our craftsmen. The smaller fragments of waste fabric are generally transported locally for industrial recycling.

Another of our key aims is to nurture creativity in the community. One part of our social-responsibility agenda is the provision of leftover textiles to kindergartens, schools and colleges for their arts and crafts programmes. In 2021, we launched a collaborative project with the Faculty of Textile Technology in Zagreb involving 1000 metres of fabrics from our previous collections. Students will be able to use the material in developing their own design ideas.

Process, Relationship and Heritage



Openness to new challenges, a gritty sense of determination and a searching spirit guided by new values merge into continuous process at Prostoria. It is a philosophy that has over the years become our trademark. Our industrial base, regardless of how big it may have grown, remains in its essence a creative workshop led by craftsmen who have grown to become masters in their given fields. Over the years our craftsmen have learned from our designers, and our designers have learned from our craftsmen, frequently over the course of collaborative projects that may last months or years. What has arisen from this is far more than just a line of furniture products. It is a blend of teamwork and living knowledge, and as such lies at the heart of all of Prostoria's activities.

Although it was the importance of design that radically defined our product portfolio and the identity of the brand, we continue to regard design as a tool for ensuring both the authenticity and the quality of the product rather than an end in itself. Design encouraged us to research manufacturing technologies more deeply, and to explore the numerous possibilities offered by our chosen materials. As many will agree, design is not so much a magic potion as a benign spirit that inhabits all aspects of what is a rather complex company, helping the whole body to stay in the full bloom of health.

Behind this impressive record of creativity and commercial success stands Prostoria's founder Tomislav Knezović, although to be fair, he does not so much stand as move, propelling his team ever onwards towards new challenges. Knezović has spent his entire professional life in the furniture business, and somewhat untypically for an entrepreneur, continues to regard product development as his preferred place of work. Initially kindled by his architect wife, Knezović's passion for good design was developed further by his instinctual feeling for quality and craft. Cooperation with designers has resulted in a particular form of synergy, and a palpable sense of quest that has filtered down through all sections of the company. It comes as no surprise that Prostoria has, in the space of ten years, grown from being a small manufacturer of upholstered furniture into a formidable industrial operation based on a philosophy of research-based design — and whose products have gone forth to furnish public and residential interiors all around the world.

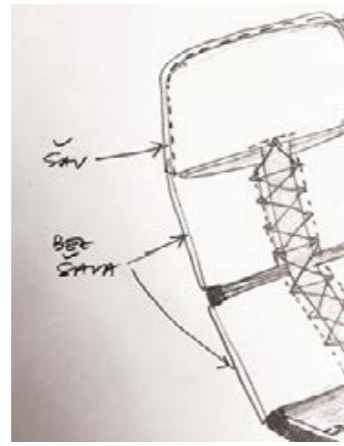
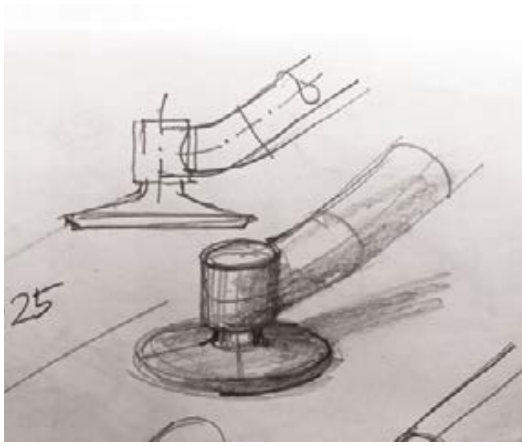

Prostoria was born into an industry that did not have a natural leader and succeeded, with time, to win that position for itself. It grew on the ruins of a once powerful Croatian furniture industry, propelled into decline by the transition from social ownership to free-market capitalism. Prostoria decided to base its manufacturing culture on the use of high-quality Croatian timber, especially Slavonian Oak,

as well as the tradition of making furniture from solid wood.

Far from being planned in advance, the identity of Prostoria grew spontaneously out of its constantly developing language of design. And if Prostoria did have a manifesto it would boil down to this: achieving the functionality of a product through a combination of understated beauty and supreme comfort. It's as an expression of functional minimalism that Prostoria's products have helped revolutionize the culture of design in today's Croatia, and to change radically the attitude of both institutions and individuals to the selection and purchase of the furniture they need. Prostoria has emerged as standard-bearer for the region's rich traditions not only in furniture production but also in architecture and interior design. In this way Prostoria can be seen as the natural heir to the culture of high modernism defined by the work of architects such as Bernardo Bernardi, Marijan Haberle, Ninoslav Kučan, Radovan Nikšić, Kazimir Ostrogović, Vjenceslav Richter, Ivan Vitić and Niko Kralj.



Facts and Figures

100%
In-house Production

233
People
(50% Women, 50% Men)

25
People in R&D

180
People in Production

10%
Investment in R&D and
Design

4
Flagship Stores

42
Collections

130
Products

13
Designers

60+
Sales in Countries

1000+
Sales in Premium Stores

10 Years of Prostoria

2011 Production in one Factory Hall (4500m²)
Product Release: Revolve

2012 First time at Imm Cologne Fair
Red Dot Award Winner: Revolve
Product Releases: 3angle, Cloud, Match

2013 Flagship Store Zagreb
Product Releases: Pil-low, Up-lift,
Polygon, Segment

2014 First time at Maison&Objet, Orgatec, Interieur
Kortrijk and Stockholm Furniture Fair
Oblique (first use of the moulded foam)
Interior Innovation Award Winner: Up-lift
and Polygon
Product Release: Monk

2015 First time at The Milan Furniture Fair
German Design Award Winner: Polygon
Interior Innovation Award Winner: Seam
and Strain
Red Dot Award Winner: Strain and Oblique
IF Design Award Winner: Seam
Product Release: Combine

2016 New Carpentry Facilities (2250m²)
Product Releases: Rhomb, Dobra,
Convert, Osmo

2017 Wood Drying Facility (4000m²)
German Design Award Winner: Rhomb
Product Release: Trifidae

2018 New Metalwork Facility (3250m²)
Flagship Store Rijeka
Štof by Prostoria (Sustainability Platform)
Product Releases: Fade, Bik, Impression,
Umomoku

2019 Flagship Store Split
Named leading design company in the SEE
region by 58th Int'l Furniture Fair in Belgrade
German Design Award Winner: Trifidae
Product Release: Absent

2020 Revisiting Analogue Project
Product Releases: Layout, Kontrapunkt,
Bavul, Piun, Tinker

2021 100% In-house production four factory halls,
20000m²
German Brand Award Winner
(Excellent Brands, Interior & Living)
Revisiting Factory Project
Product Releases: Jugo, Knif, Echo, Klaster

2022 Prostoria Design Living Lab is a research
and educational platform where we'll plant
innovative ideas and put them into action.

Revisiting Architecture 28— 115

Revisiting our Modernist Architectural Heritage



Few cities in the world can boast a modernist architectural tradition so deeply rooted as that of the Croatian capital Zagreb. And it is precisely this modernist legacy that underlies the approach to the design of Prostoria's products. We therefore devised a photography project that would explore these modernist roots by placing particular Prostoria products in front of appropriate architectural landmarks, each of which continues to play an inspirational role in terms of form, texture and modernist ambition.

The landmarks we have singled out are the Vatroslav Lisinski Concert Hall (1958-1973, architects: Marijan Haberle, Minka Jurković and Tanja Zdvořak), the House of Socio-Political Organisations or "Kockica" (1961-1968, architect: Ivan Vitić), the building the People's Assembly in Zagreb (1955-1959, currently the Zagreb City Hall; architect: Kazimir Ostrogović), The Workers' and People's University (1955-1961, architects: Radovan Nikšić, Ninoslav Kučan / interior & furniture designer: Benardo Bernardi) and the Romanian Pavilion at the Zagreb Fair (1956, architect: Ressu). This photo-editorial was produced in collaboration with the Zagreb Tourist Board and public institutions involved in the project.

Art Direction: Biro Architects

Photography: Marko Mihaljević, Jure Živković

Prostoria and Architecture

Maroje Mrduljaš

In many parts of the world modernism achieved mainstream acceptance in the mid-twentieth century only to be rejected in favour of new architectural trends, then re-embraced as an aesthetic substratum from which contemporary individual expressions emerged. For Zagreb, however, modernism has always been an undisputed and, arguably, key element in the city's urban identity. Perseverance has paid off: recently we witnessed the global canonization of Zagreb, Croatian and Yugoslav modernism at the critically acclaimed exhibition *Toward a Concrete Utopia* at the Museum of Modern Art (MoMA) in New York. Of course the enthusiasm for this kind of architecture stemmed partly from a widespread fascination with the incomplete project of building "socialism with a human face", although it was also grounded in the genuine achievements of modernist culture in architecture and design.

In a world where trends are changing at a rapid pace, the global interest in modernism in design and architecture can be interpreted in several ways: a change in academic fashion, a quest for novelty that results in the rediscovery of the old and forgotten, or simply a hashtag on Instagram void of any meaning. However, when we talk about modernism we do not refer to a specific style, but rather to an enduring set of values. That is

why we when we refer to modernism we are also referring to rationality, absence of dogmatism, openness and a willingness to research, values which all apply to the ethics and aesthetics of the architecture of the time. It is on the basis of these values that a belief matured in Zagreb during the 1950s and 1960s that there was no fundamental difference between architecture, art and design. An atmosphere of social optimism encouraged real partnership between architecture, design and other spheres of culture: theatre, film (especially animated film), the beginnings of digital art, and specific social phenomena such as the growth of new educational institutions and the emergence of Zagreb Trade Fair as an international meeting place. Indeed, modernist architecture and design emerged as key participants in a more general move towards social progress. Even if the ambition to build a radically new society proved to be too utopian, the belief that architecture and design are of broad social significance still remains valid. Zagreb modernism remains not so much a style as an attitude.

The resulting series of photographs is both a visual experiment and a collage of the best works of two different epochs. The spatial framework and the stage upon which its story is told is well thought out, distanced and refined; yet the

august modernist architecture of Zagreb during the 1950s and 1960s exudes an almost shocking degree of self-confidence. One encounters an extreme economy of expression, an architecture that speaks through spatial relationships and abstract forms but also through various objects: artworks, interior features, furniture... One is also impressed by the sheer boldness of the time, when architects were building a grand stage on which the future would be enacted, without submitting to general expectations.

These monumental public institutions have more recently housed displays of Prostoria's contemporary furniture.

Although modernist architecture and Prostoria's products are more than half a century apart, they complement each other, speak a similar language, form a natural bond, and are equally uncompromising. These set designs are neither about going back in time, nor about completing a delayed future, but celebrate converging values and continuous exploration. Due to specific social priorities, the modernism of the mid-20th century has left behind impressive public architecture, outstanding public art and some exceptional examples of product design. Today, we are witnessing a kind of inversion that is not specific only to Zagreb. The construction of public institutions was largely completed during the socialist period, even though it might nowadays be insufficiently



or inappropriately used, and more and more attention is paid to spatial recycling and the transformation of interior landscapes. The exploration of new concepts has moved away from the domain of grand gestures towards smaller scales, towards the domain of objects, towards projects which are equally demanding, but still easier to manage in a situation in which society no longer acts as a major sponsor. Prostoria's products naturally belong to the world of modernist architecture, and they clearly share common values and intellectual origins.

Prostoria's products should not solely be seen as "modernist" and they do not necessarily belong only to the design scene of Zagreb and Croatia. Designers, ambitions and targeted outreach are global. However, Prostoria does not create in a vacuum, but rather preserves and develops the values of the cultural environment from which it has emerged. The architecture of Zagreb's public institutions in the 1950s and 1960s meant a lot more than the individual buildings themselves: it acted as a mediator between global culture and the local context, and it changed the identity of the city by making it more open and more modern... In a similar way, Prostoria functions as a platform that allows designers to merge the ethics and aesthetics, creating products grounded in solid values.

**Vatroslav Lisinski
Concert Hall 1958—
1973**



The Vatroslav Lisinski Concert Hall is one of Zagreb's most iconic architectural landmarks. With its glass body characterised by a simple, direct geometry, it makes for a classic minimalist gesture. However, its truly innovative aspects only become apparent at night, when the lights are turned on and the audience can be seen milling and socialising inside the building. The building was specifically designed to be a showcase for a unique social event — the act of going to a concert. In place of a single main lobby, a continuous ring of multi-storey public spaces spreads around the entire perimeter of the building, enclosing the concert hall and opening up panoramic views of the city.

Architecture is reduced to its essentials: pillars and visible elements of the construction consist of bare unplastered concrete, partitions in the interior are made of industrial glass, while wood appears only in details. Although there are no distinct design features in the interior, a lavish set of glass chandeliers, reminiscent of floating sculptures, serve to counterpoint the ascetic architecture. The concert hall itself resembles a large wooden box, exuding warmth through a slightly distorted geometry that contributes both to the formal richness of the space and its outstanding acoustic properties. The building's strict architectural discipline of "pure space" helps to place the emphasis on the various events that take place within it, and it is from this that its aura of luxury and prestige derives.

Architects: Marijan Haberle, Minka Jurković and Tanja Zdvořak









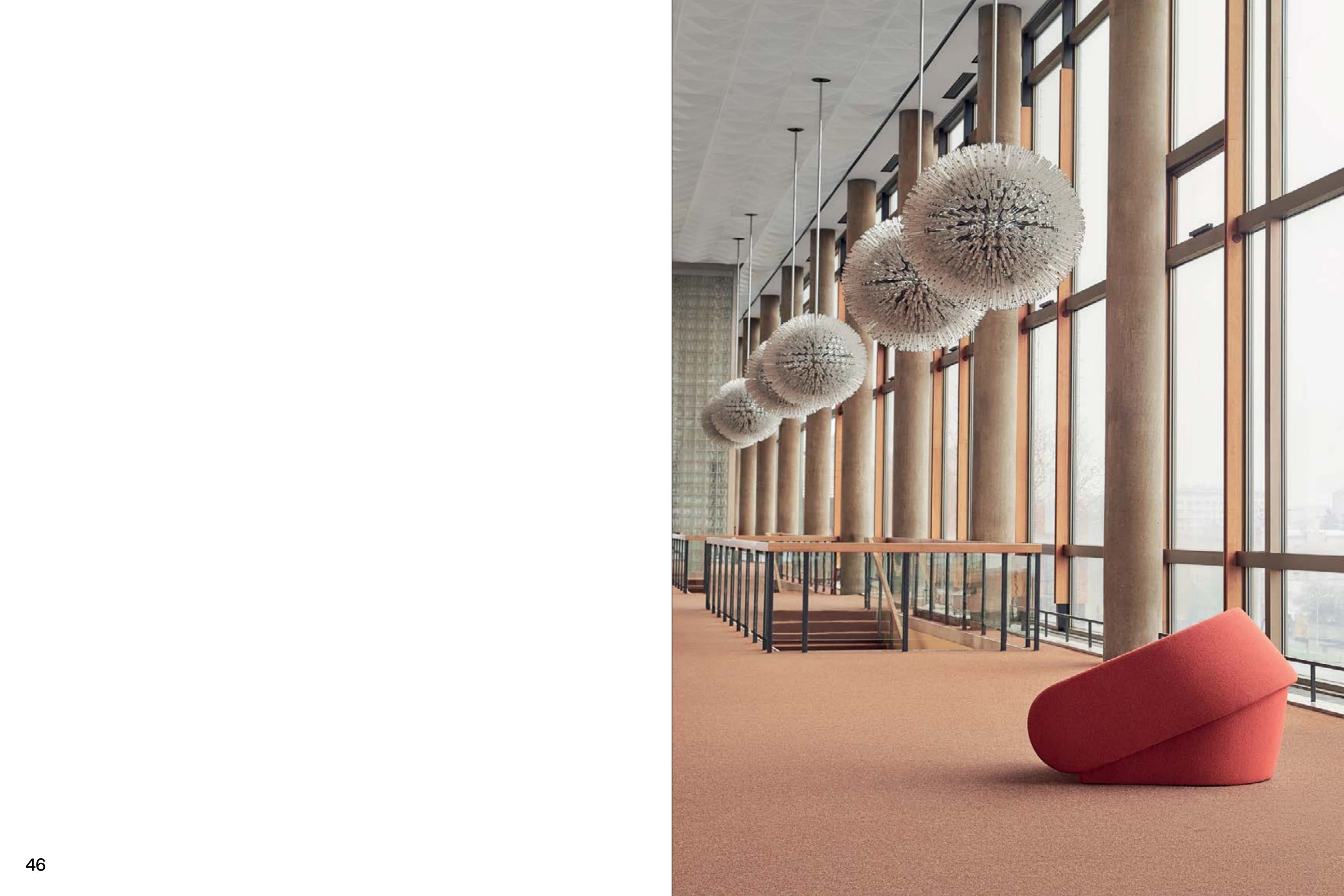



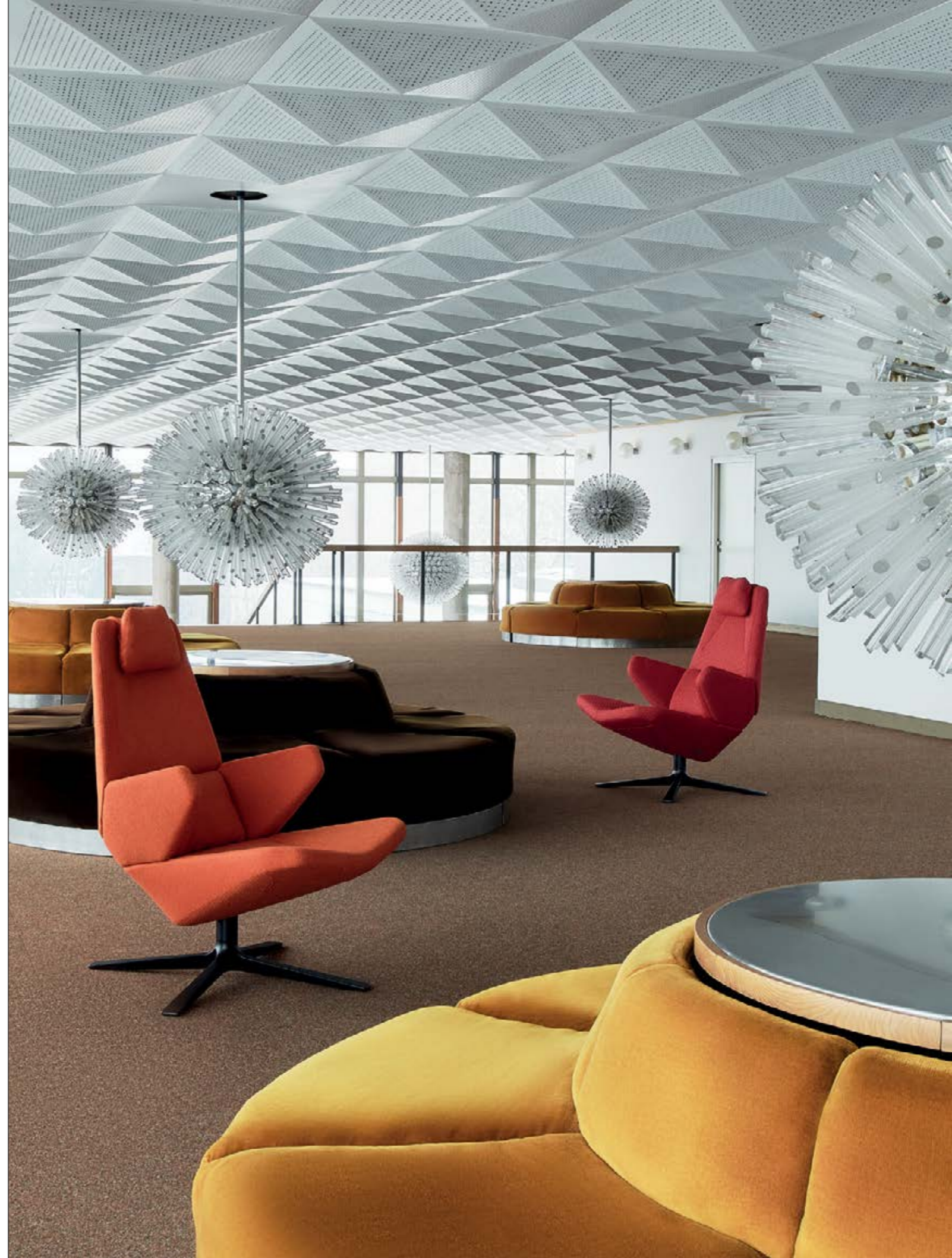





Kockica, House of Socio-Political Organisations 1961 —1968



Located in close proximity to the River Sava, the former House of Socio-Political Organisations, currently the seat of two government ministries, remains to this day a lonely survivor of a waterfront project that was never fully realised. However, it is a context that actually suits the building: its striking volume stands like a giant sculpture touching the gently undulating, vast void of the river's flood plain. The modernist form of this erstwhile fortress of the Croatian League of Communists, the heart of power during the socialist period, inspired its popular nick-name — Kockica, or “dice” in Croatian. The building combines monumental representational requirements with modernist aesthetics.

The interior of the building contains an impressive collection of site-specific works of art, some of which are truly gigantic. Thus, in the large hall we find a metal relief by Stevan Luketić, and a mosaic by Zlatko Prica. Also on a huge scale are two complementary yet quite distinctive artistic visions. In the entrance hall is Raoul Goldoni's set of partition walls, rendered in specially shaped blue glass bricks; while the space is further enriched by the artistic interventions of Edo Murtić, Jagoda Buić and Dušan Džamonja. These artists were among the most highly respected in Croatia and Yugoslavia at that time, and the building's interior provided them with a unique opportunity to experiment on a huge scale. Kockica houses a unique collection of artworks from the period of high modernism, integrated into an architecture that is equally impressive.

Architect: Ivan Vitić

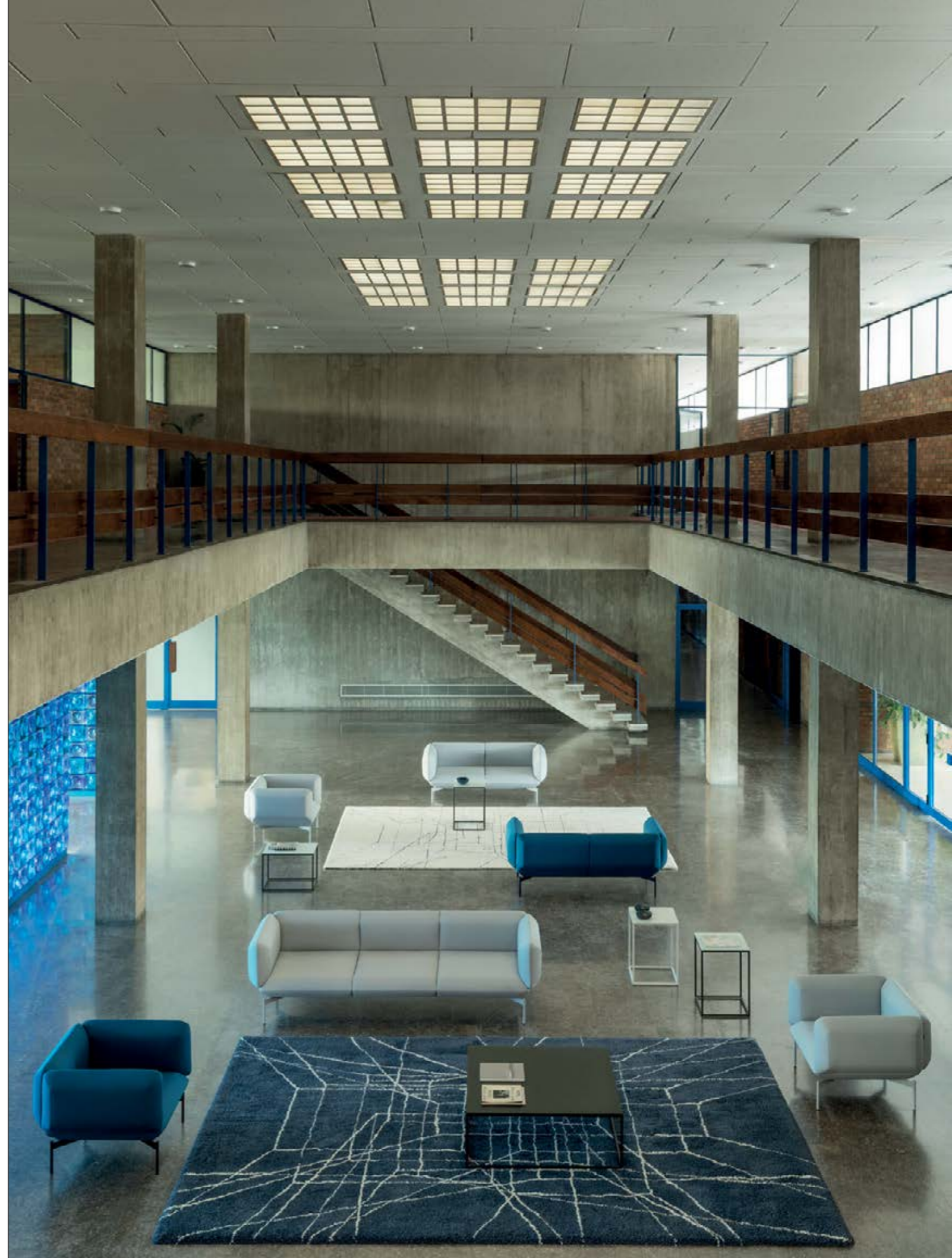















**People's Council
Building 1955—
1959 Zagreb City
Hall**



The People's Council Building in Zagreb, today the City Hall, marks the very beginning of the architectural modernisation of Zagreb after WWII. Located at the intersection of two new city avenues: the then Proleterskih brigada Street (today Vukovar Avenue) and the newly planned north-south main city axis, the building was to become the centre of a modernist city that would act as a counterpoint to the historical city core. These plans were never realised on quite the scale initially intended. However, the concept of the building derives directly from an urban concept according to which the citizens of a "futuristic" and functional city would walk on platforms under which car traffic would flow, and the roofs of the buildings would function as terraces. It is for that reason that the building hovers dramatically on pillars with a canopy above the roof. Like the broader urban concept of which it was intended to be a part, the complex itself has remained unfinished, accompanied as it was by ambitious plans to build a neighbouring skyscraper and a congress hall.

The elegant façade is made of stone, and the details of continuous glass surfaces are designed so that the volume appears as flat and "abstract" as possible. The main entrance hall with its zenithal light is five-floors high and represents the most monumental modernist interior in Zagreb. The building conceals two deep atriums freely accessible from the public space, which were meticulously designed by the brilliant landscape architect Silvana Seissel as part of a more comprehensive park landscape design. In the atriums, an exciting dialogue emerges between robust architecture and subtle landscaping. The building clearly communicates the prestige of a public institution and symbolises the optimism of the late 1950s, when modern architecture and the emerging contours of a new Zagreb offered hints as to what a better future might look like.

Architect: Kazimir Ostrogović













**Workers' and
People's University
1955—1961**



Workers' and people's universities sprang up throughout Croatia and the former Yugoslavia during the socialist period, when they were seen as central to the grand project of social emancipation. These institutions aimed to bridge the gaps between “high” and “popular” culture, education and entertainment, and professionalism and amateurism in various creative domains.

The Workers' and People's University of Zagreb (RANS) is arguably the most fully-realised example of these aspirations. It is located at the entrance to “University Alley” — a city-centre district characterised by modernist structures housing higher-education institutions. The building's well-thought-out asymmetrical composition reflects its many intended uses, with a large and a small hall, a series of lecture halls, a library, a restaurant and other amenities connected by wide passages. It's this generous provision of interconnecting public spaces that lies at the core of the building's philosophy. Spacious corridors and staircases meander freely through the building in three dimensions, stimulating people to walk and explore. This results in unexpected interactions between diverse groups of users. Displaying similar intentions is the multi-purpose space intended for exhibitions and informal teaching. The two atriums provide a glimpse of greenery and ensure an abundant flow of light into the interior of the building. The monochrome interior is designed under the influence of Neoplasticism as a “three-dimensional image” in which all the lines in the space are carefully aligned and coordinated. The interior is at the same time subtle and finished with prestigious stone surfaces. It is equipped with furniture specially designed for the building by Bernard Bernardi. In this “temple of workers' emancipation”, which was presented as an outstanding example of progressive architecture at the first meeting of the international avant-garde group Team X in Otterlo in 1958, is the perfect combination of noble social ambitions and Croatian architectural culture.

Architect: Radovan Nikšić, Ninoslav Kučan
Interior & Furniture Designer: Benardo Bernardi











Koje knjige su vam danas poznaje i citate?



Kome ste trenutno najviše razumjeli i svi odgovorili?



Kakav je vaš omiljeni roman?



Čije je vaše omiljeno izdanje knjige?



"Miroslav" (br. 5-6)

1969

1970

1971

Najviše mi se pojedine književnici koje objavljujete uz pripovjetke. Neki nisu izgledaju tako ružno da nekad izgubim volju da pročitam pripovjetku. Ostali fotosi vam dobro uspijevaju. Da li je kriv papir, ili nešto drugo?
Rupić



1972

1973

1974

1975

1976

U knjizi "15 DANI" dolazim na neke nepoznatije koje mi otkrivaju da razumijem stvari. Dali bi se njihova djela mogla praveći na naš jeziku?

D.



1977

1978

1979

1980

1981

"Elogij" (br. 2-3)

Na upit, bi li željeli da se slijedi in. Liječnik u povećanog formata izlazi roman u nastavcima: svi su odgovorili jače, a time, da roman bude "kvalitetan", a ne "buna". Sreće je Milan Protulipić bio u opoziciji, jer - kako on kaže - "mi nemamo vremena za čitanje romana, već samo za učenje."

Protulipić



1982

1983

1984

1985

"Wim Wenders" (br. 1-2)

Zbog nestajanja papira prvi broj ovog je izdanja znatno kasni. Molimo čitatelje da to uzaju.



Romanian Pavilion 1956 Zagreb Fair



Zagreb is a city with a long tradition of trade fairs. In 1956, on the initiative of Zagreb's visionary mayor Većeslav Holjevac, a new modernist complex of trade-fair buildings was begun on the south bank of the River Sava, an area where there was no other urban development at the time. The effect was twofold. Firstly, the Zagreb Fair stimulated the development of so-called Novi Zagreb or "New Zagreb", a major expansion of the city that envisaged the construction of extensive new residential districts. Secondly, the Fair became an important meeting place for the communist "East", the capitalist "West", and the "Non-Aligned" countries of the Global South. The concept of the fair grounds was unique: in place of large anonymous halls, an attractive area of avenues and parks was designed, with each pavilion regarded as an opportunity for an architectural experiment, much in the same way as at World Exhibitions or EXPOs. Both Croatian and international architects were invited to design individual pavilions, and from the 1950s to the 1970s, the Fair became the cosmopolitan site of genuine architectural competition.

Among the several Croatian-designed pavilions that are considered architectural masterpieces, one of the most significant, and also one of the oldest, is the Romanian Pavilion. It was built in 1956 on the Alley of Nations, the complex's main thoroughfare. This compact building, designed by the architect known in Zagreb only by the surname "Ressu" (which is also the surname of one of the most important Romanian painters of the first half of the 20th century), is a beautiful example of early brutalism. In 1962 the Romanian Pavilion became the showroom of the local furniture distributor Exportdrvo. The façade of the pavilion consists of a dynamic three-dimensional concrete structure, while its interior differs considerably from that of most other pavilions. Instead of a single large space, the pavilion is divided into a series of interconnected spaces of different proportions. Due to its spatial complexity, the pavilion has been used for numerous art and design exhibitions, including those organised by Zagreb's prestigious Museum of Contemporary Art.

Architect: Ressu









2

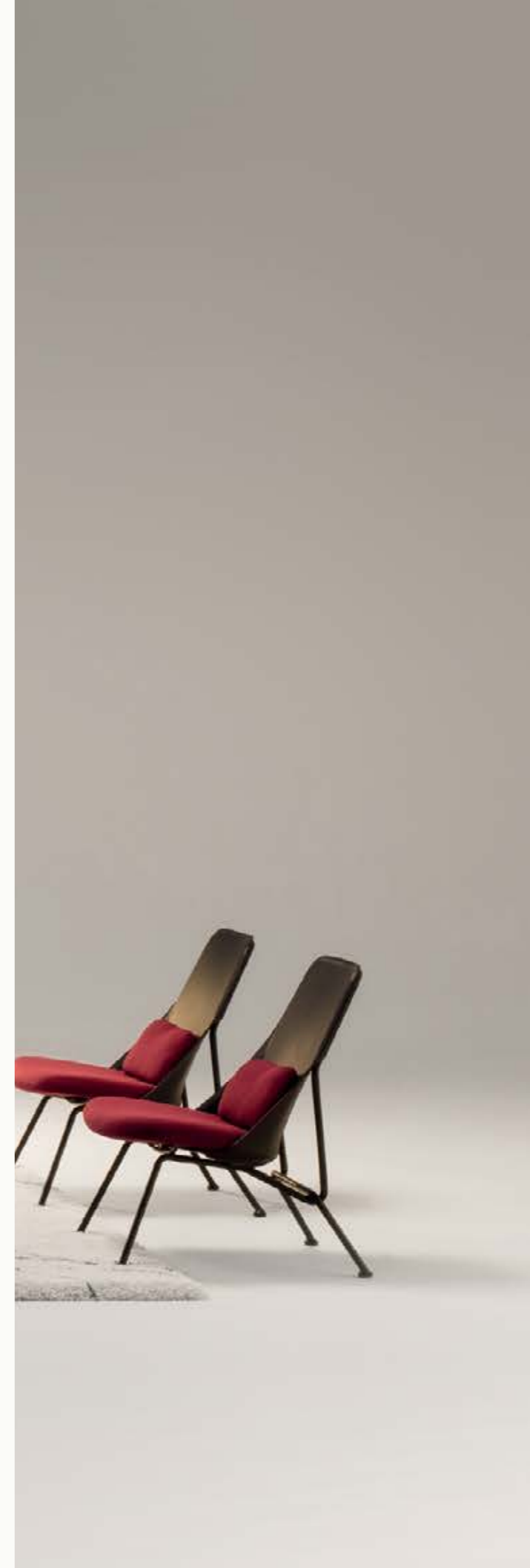



Our ambition is to push the boundaries of both materials and form, through the creation of a diverse range of products while using a unified language of design. This selection from our extensive collections highlights their functional minimalism, the long-lasting degree of comfort and vitality they bring.



Sofas, Sofabeds and Accessories 118—263

Match is a modular sofa providing both a welcoming space and an experience of supreme comfort. The defining lines of its design are the lower-than-usual backrest and elevated armrest, while the cold foam fills its volume with sufficient firmness for comfortable sitting. The cover made of natural materials enhances the experience of relaxation. Match's dimensions go hand-in-hand with the needs of diverse groups of users who can chose between two different widths and depths of the module.

Design: Sanja Knezović

Match





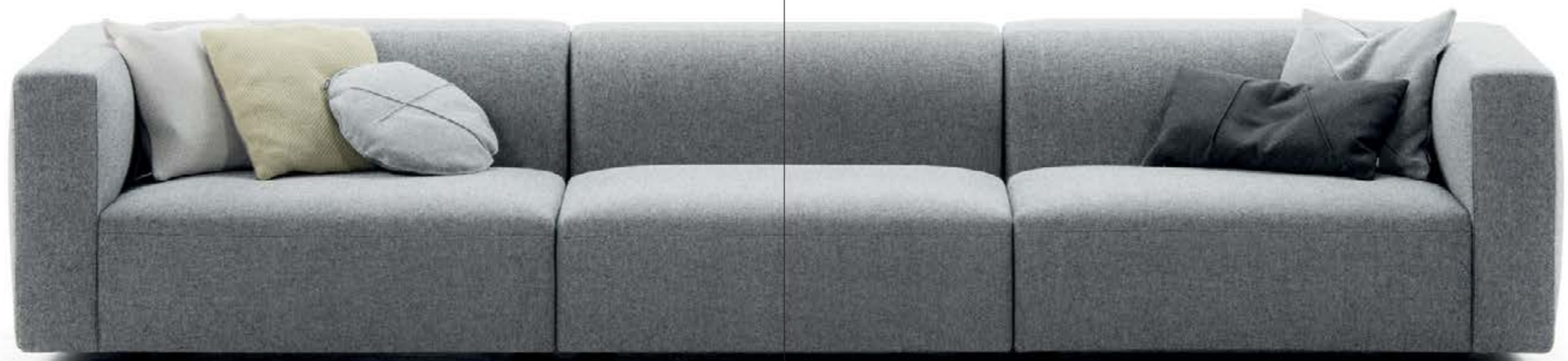



1 Seater

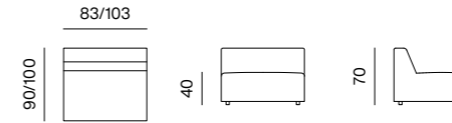

Corner

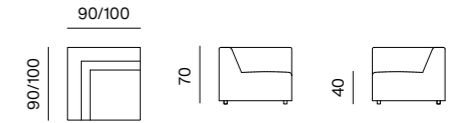

1 Seater with Armrest (L/R)

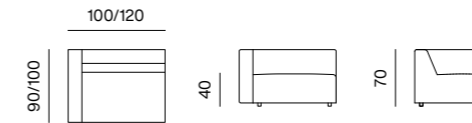

Corner Asymmetrical (L/R)

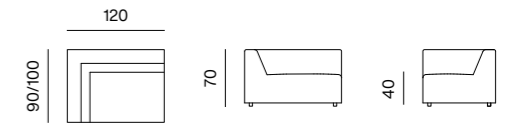

1 Seater Extended (L/R)

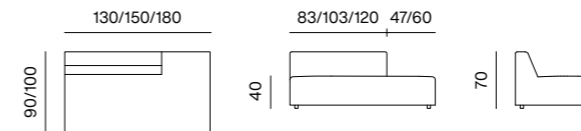

Corner Extended (L/R)

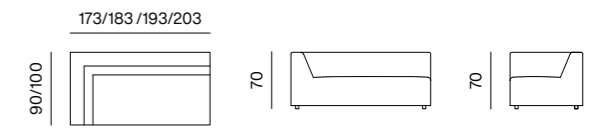

2 Seater

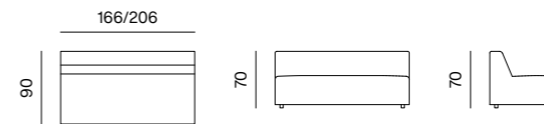

Island



2 Seater with Armrest (L/R)

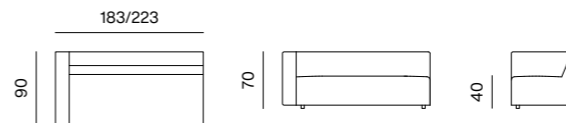

Armchair

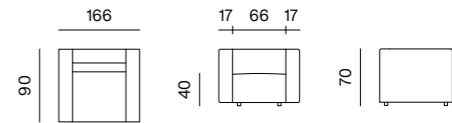

2 Seater Sofa

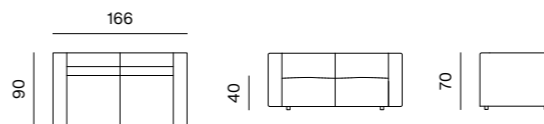

Pouf

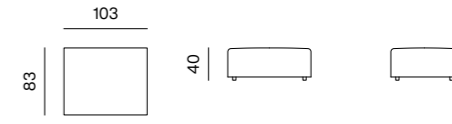

2.5 Seater Sofa

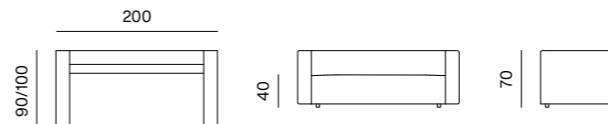

Pouf 100/120

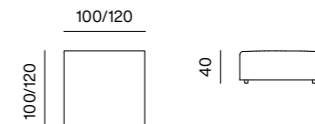

3 Seater Sofa

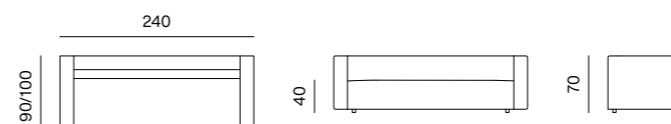

Chaise Longue (L/R)

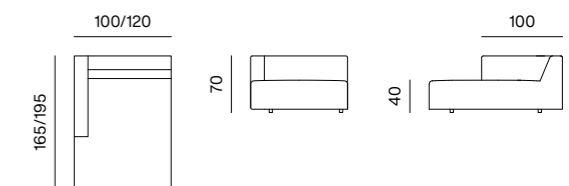

Cloud is a modular sofa that provides the ultimate experience of comfort. Its minimalistic form, comprising of a relatively low backrest and elevated armrest, covers a mass of cold foam that reinforces its volume, while a superficial layer of feather filling adds extra softness and a luxurious feeling of 'relaxation in the clouds'. Cloud's dimensions are intended to suit the needs of a diverse group of users. Its shape and volume is ideal for the furnishing of larger spaces.

Design: Sanja Knezović

Cloud









Armchair

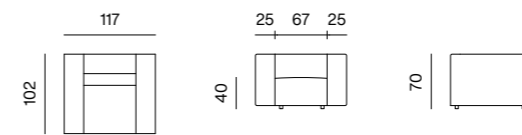

Corner

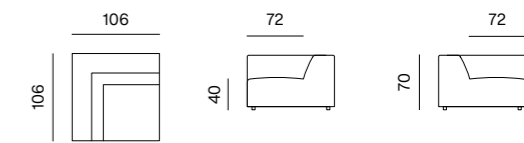

1Seater

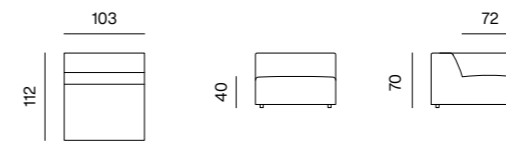

Corner Asymmetrical (L/R)

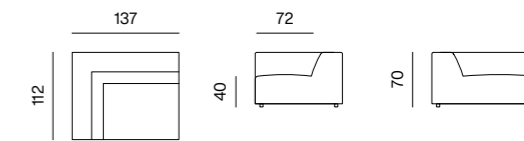

1Seater with Armrest Low/High (L/R)

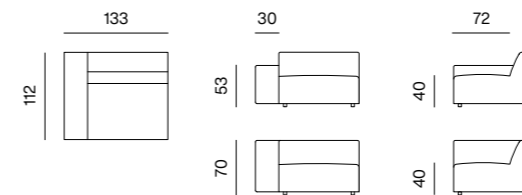

Island

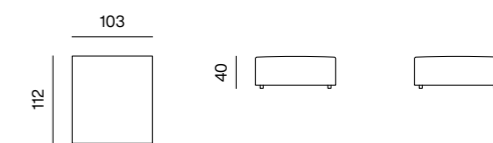

1Seater Extended 153/183 (L/R)

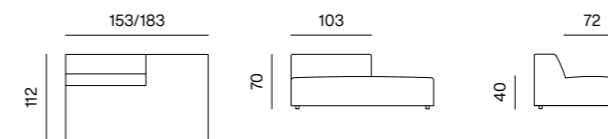

Pouf

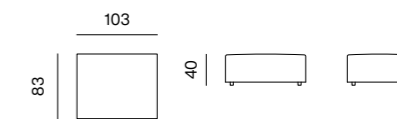

Chaise Longue 177/207 (L/R) / Chaise Longue Solo 177/207 (L/R)

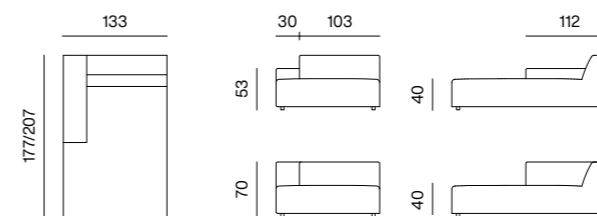

Pouf 112

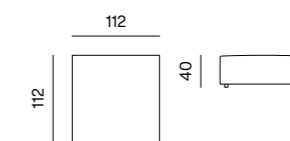

Unfolding as a fluid organic shape, Absent is a sofa designed for a body position in-between sitting and lying down. Using cold foam compositions, the sofa's ergonomic design provides premium comfort and a fully customised lounging experience with a futuristic flair. This sofa system combines various backrest heights with different seat depths, while the soft cushion adds to its ergonomics and particular sensual experience. With Absent you can simply glide into a comfort zone, an inner dimension where you can feel weightless and safe.

Design: Numen / For Use

Absent











Seat S, Backrest Low

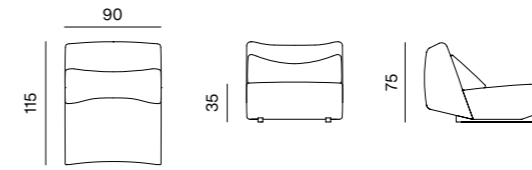

Seat S, Backrest High

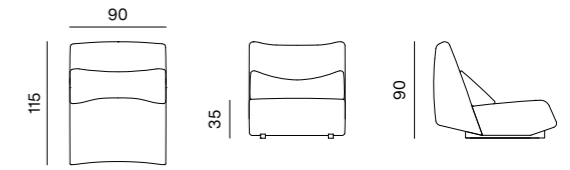

Seat M, Backrest Low

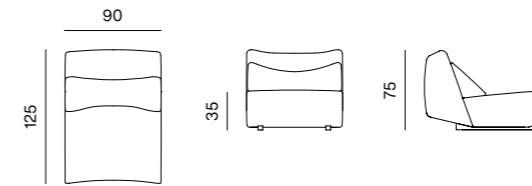

Seat M, Backrest High

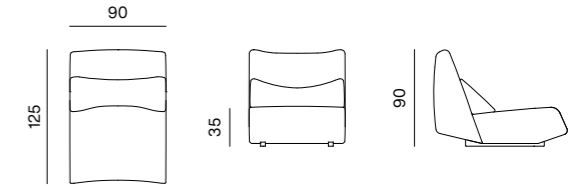

Seat L, Backrest Low

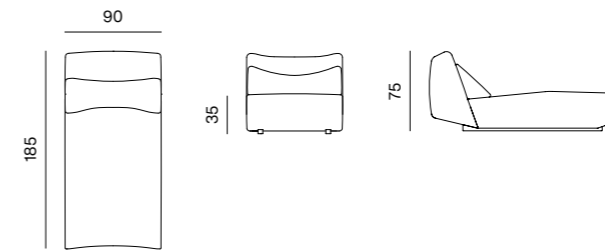

Seat L, Backrest High

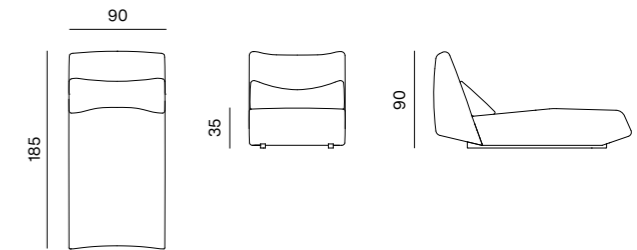

Corner S Low / Corner M Low

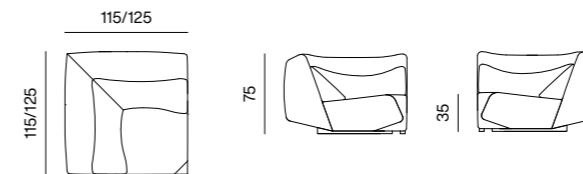

Pouf

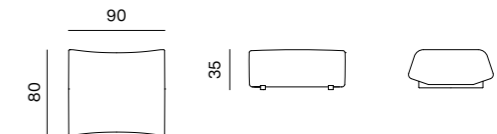

The Layout modular sofa with its seamlessly interconnected seats and poufs, creates a soft terrain of sloping surfaces that are supremely adaptable to the needs of leisure and socialising at home. Its pliable design also helps to bring the ultimate comfort of a home sofa into an office environment, hotel lobby or airport lounge, offering a cocoon of privacy in a public space. The design consists of four elements (a seater with backrest, two corners and a pouf), enabling an endless number of interior configurations.

Design: Numen / For Use

Layout











1Seater

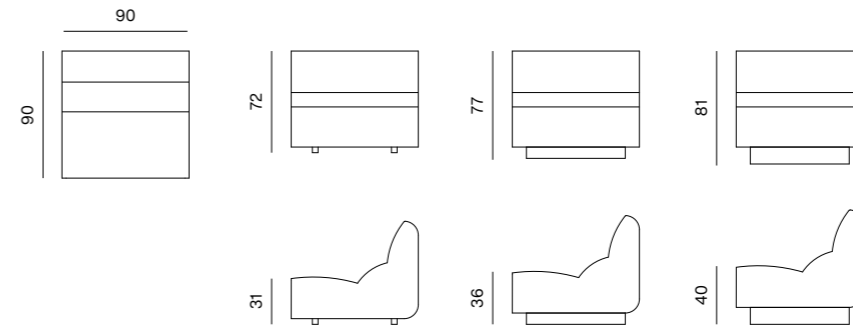

Pouf

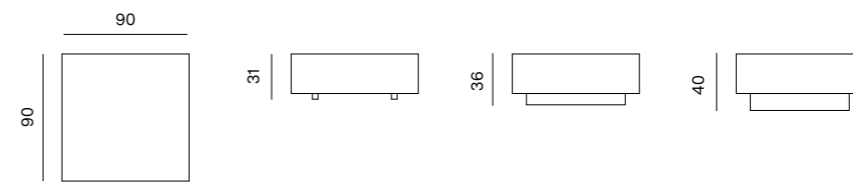

Corner

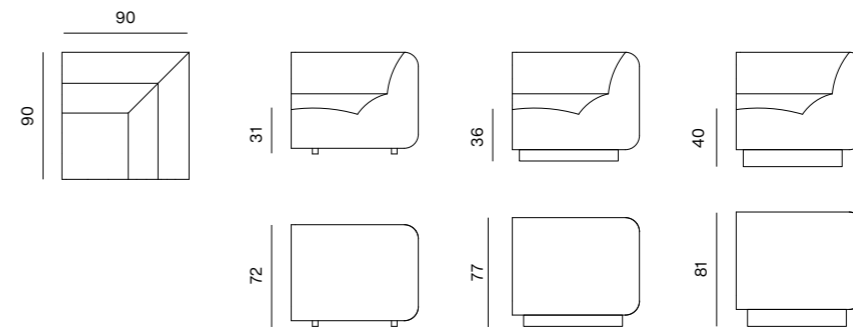

Outer Corner

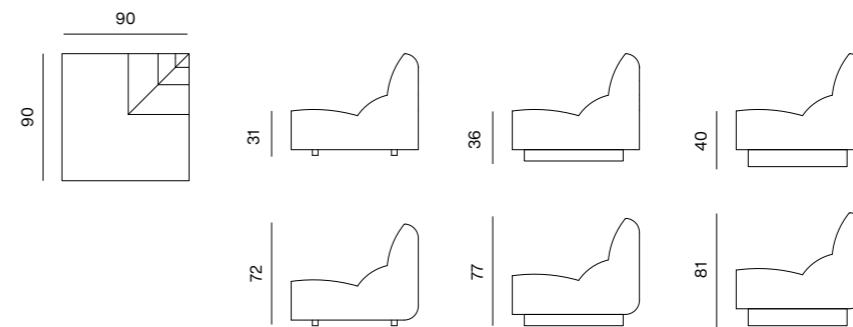

Klaster is a flexible modular system made up of minimalist cubes. It consists of 14 modules: six seats, four low and four high backrests and three sofa bed modules which can be freely combined into any number of exciting configurations. The visual identity of the modules aims for a certain degree of neutrality, thereby enabling maximum creativity when it comes to their arrangement and use. The sofa bed modules can be combined with other modules to build bigger compositions. Thanks to the variety of the modules and their multifunctionality, Klaster is equally suitable for both domestic interior and public space.

Design: Numen / For Use

Klaster



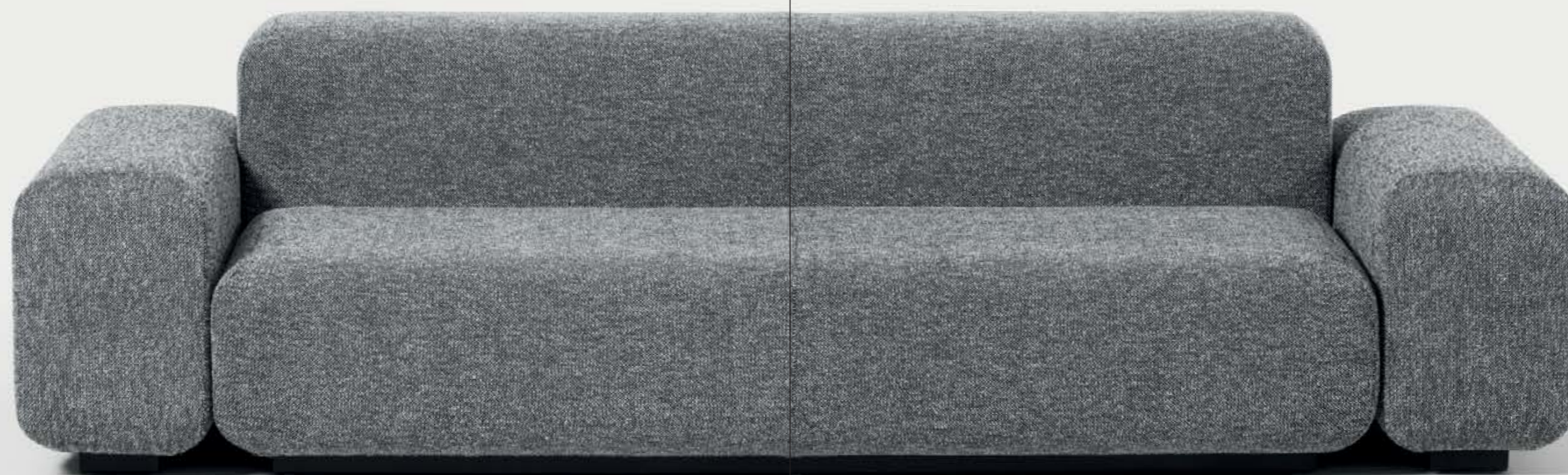



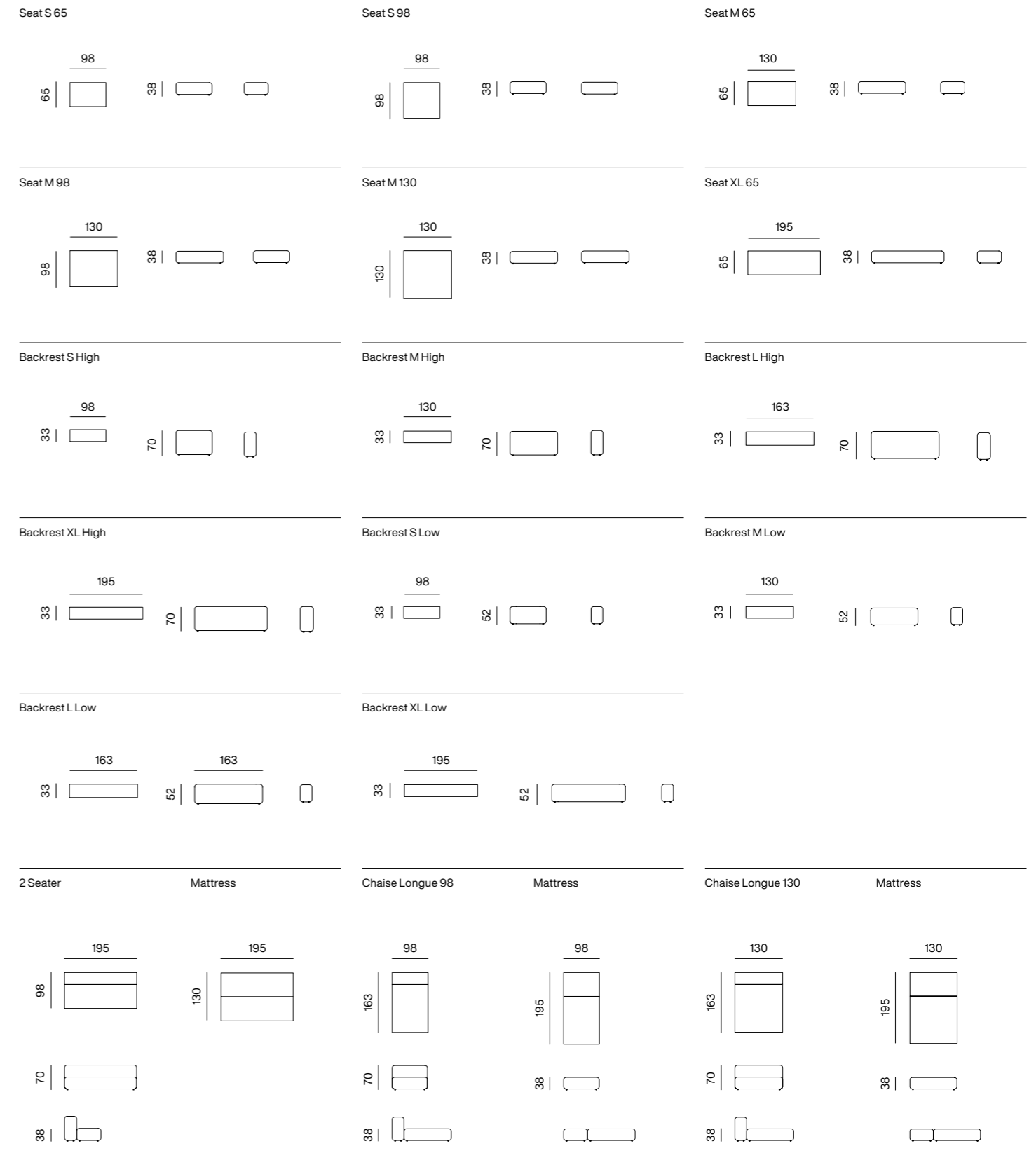

The Echo modular sofa provides an exceptionally relaxing experience of lying on the most comfortable bed. This sumptuous quality of comfort extends to the overall design of the sofa, and is especially accentuated in its seating cushion. The sofa is suitable for both informal sitting and lying down, as the backrest and armrest are ergonomically adapted for relaxed reclining. Echo is also available in regular seating depth modules and can be used in business premises. The whole system is supremely modular as it allows diverse combinations in terms of length and width. Echo comes in textile or in combination with leather on the outer sides of the backrest and armrests.

Design: Grupa

Echo









1 Seater



1 Seater with Armrest (L/R)

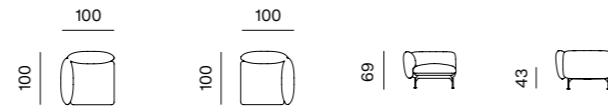

Armchair



1.5 Seater



1.5 Seater with Armrest (L/R)

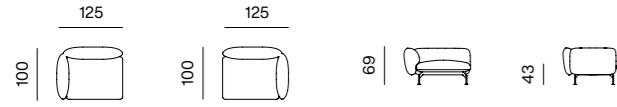

Armchair 138



1.5 Seater Deep



1.5 Seater Deep with Armrest 85 (L/R)

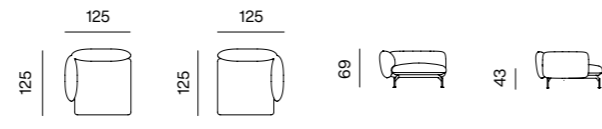

1.5 Seater Deep with Armrest 110 (L/R)

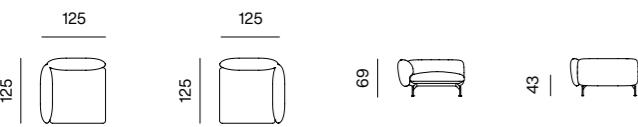

2 Seater



2 Seater with Armrest (L/R)

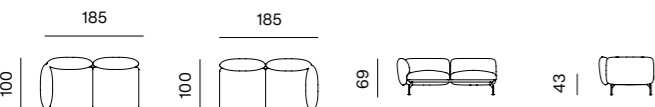

2 Seater Sofa



2.5 Seater



2.5 Seater with Armrest (L/R)

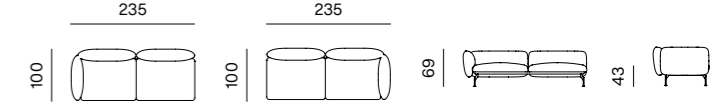

2.5 Seater Sofa



2.5 Seater Deep

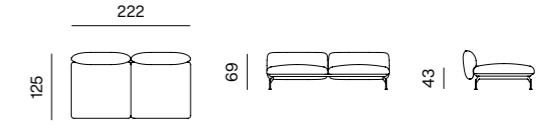

2.5 Seater Deep with Armrest 85 (L/R)

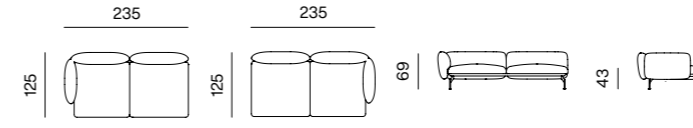

2.5 Seater Sofa 85 Deep

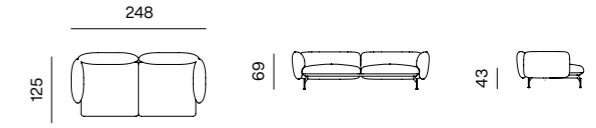

2.5 Seater with Armrest (L/R)

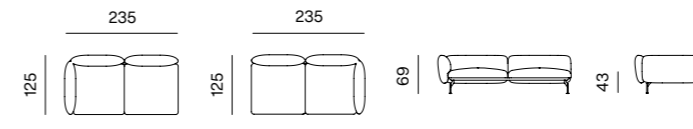

2.5 Seater Sofa 110

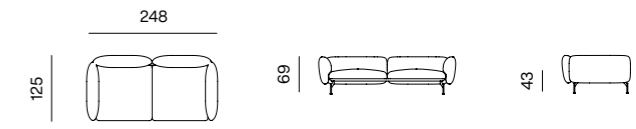

3 Seater Sofa



3 Seater with Armrest (L/R)

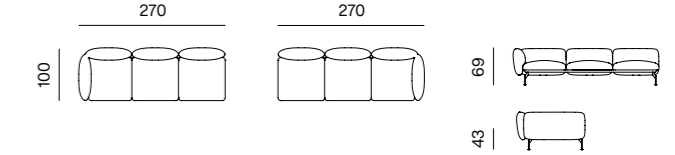

Combine is a seating system with reduced form characterised by the profile of the lower side of the backrest. Depending on the choice of leg finishings, made in solid wood and cushions, Combine's style and the context of its usage varies, enabling the user to impose their own preferred character on the sofa and its surroundings.

Design: Numen / For Use

Combine









2 Seater Sofa / 2.5 Seater Sofa / 3 Seater Sofa



Wooden Base

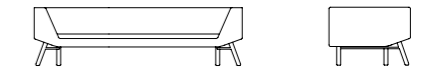

End Unit (L/R)

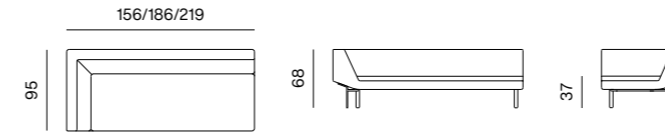

Wooden Base

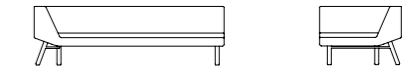

Chaise Longue Open End (L/R) 186

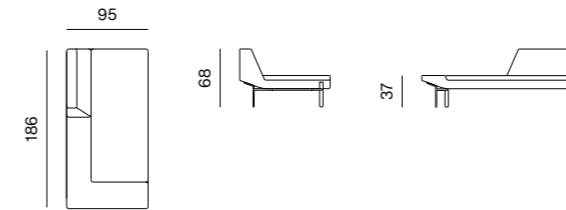

Wooden Base



Chaise Longue (L/R) 177

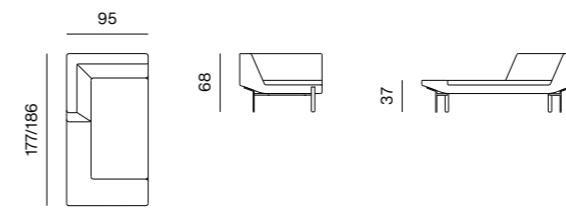

Wooden Base



Chaise Longue (L/R) 207/240

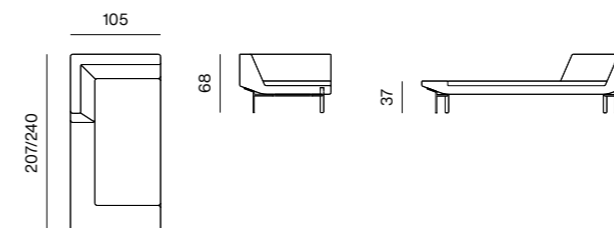

Wooden Base



The Impression sofa simultaneously incorporates elegance and comfort. Low and slim armrests and backrest form a gentle impression with curved inner components providing comfortable seating. Filigree but strong legs emphasise a fresh look. Delicate appearance is combined with a special detail on the armrests. An impression on each corner is repeated also on added cushions. The sofa comes with open-end modules, which accommodate various different compositions.

Design: Meike Harde

Impression









Armchair, Base 01



Base 02



2 Seater Sofa / 2.5 Seater Sofa / 3 Seater Sofa, Base 01



Base 02



Chaise Longue (L/R), Base 01



Base 02

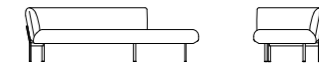

End Unit (L/R), Base 01



Base 02

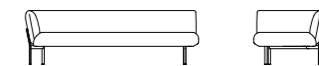

Convert is a modular seating system providing various combinations and compositions in space. Its flexible structure can be modified over time. Changing of the position of the seating modules, fixed backrests or the ones with a mechanism and a platform for storage, offers a variety of different possibilities applicable to both residential and public interiors. Essentially discreet in its shape, through the disposition of structural elements, the selection of the material and the choice of cushions, the system changes its character and function depending on the preference of the user.

Design: Simon Morasi Piperčić

Convert









3 Seater / 3 Seater with Armrest (L/R) / 3 Seater Sofa / 3 Seater Sofa with Sideboard (L/R)

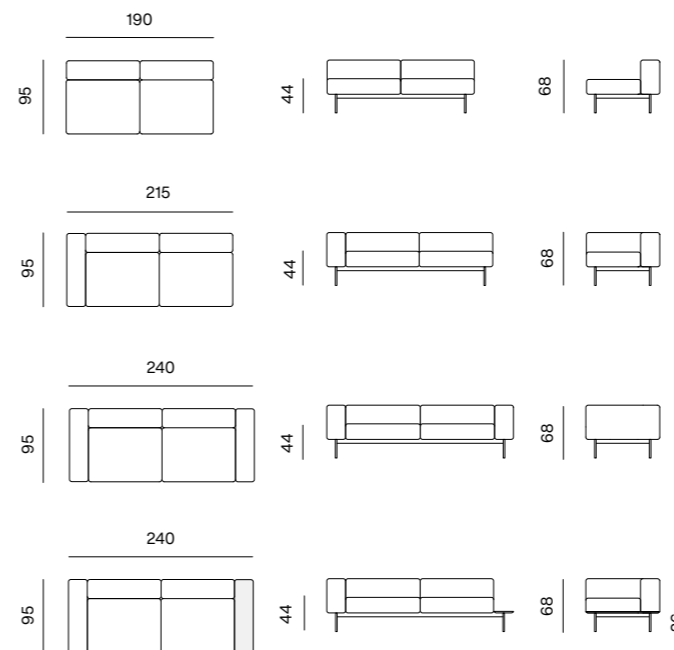

Armchair

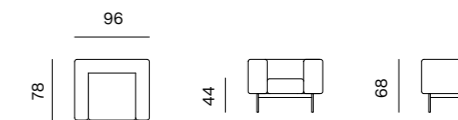

Chaise Longue with Sideboard

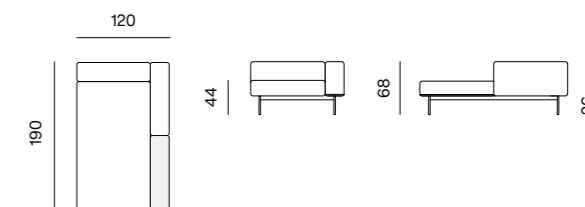

Pouf / Bench

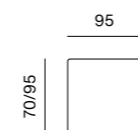

Pouf / Bench

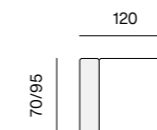

Example Large Composition

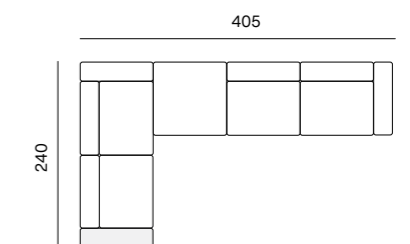

Pouf / Bench

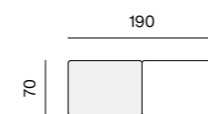

Pouf / Bench



Seat

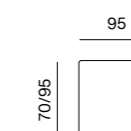

Seat Chaise Lounge

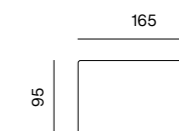

Sideboard

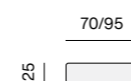

Sideboard

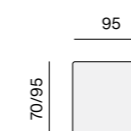

Armrest / Backrest

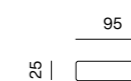

Backrest with Mechanism



Segment is a modular system available as a multi-base series of components that can form various functional or unconventional compositions. Its identity is determined by the form of its main component with its characteristic basic double-sided ends sloping at a 45° angle, which offers perfect ergonomics. The combinations in a series of multiple bases can on one side be supported by a metal feet, while a supporting wooden component with a high lustre finish can extend from beneath the base on the other side.

Design: Numen / For Use

Segment









Armchair



Pouf



2 Seater



Composition 01

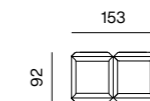

2 Seater Snake



Composition 02, Platform 204 (L/R)



3 Seater



Composition 03, Platform 204 (L/R)



3 Seater Snake



Composition 03, Platform 272 (L/R)



4 Seater



Composition 04 (L/R)



4 Seater Snake

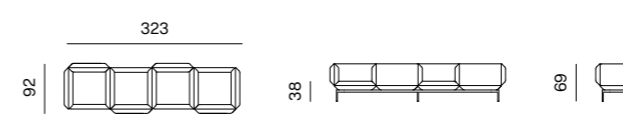

Composition 05 (L/R)

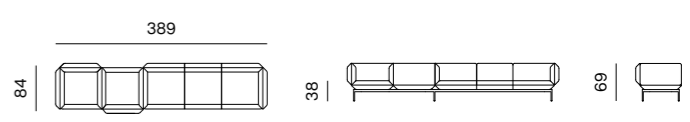

Corner 01 (L/R)

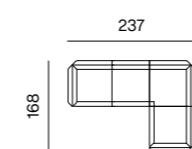

Corner 02 (L/R)

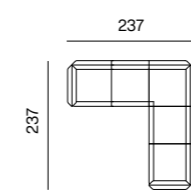

Corner 03 (L/R)

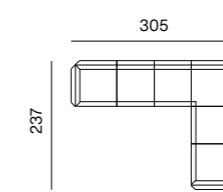

Corner 04 (L/R) Platform 204

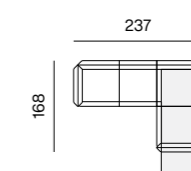

Corner 04 (L/R) Platform 272

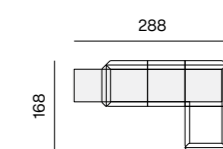

Corner 04 (L/R) Platform 272

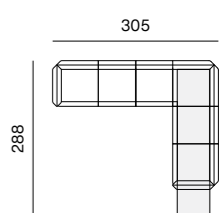

The design of the Seam sofa integrates elegant form and purity of a single volume for comfortable seating, without cushions that are often reminiscent of residential settings. The extremely deep armrest and backrest sink in an expressive curve towards the seat, which represents an ergonomic solution and at the same time highlight the sofa's design. The geometry of the curvature is accentuated with the stitches on the covers.

Design: Böttcher & Kayser

Seam

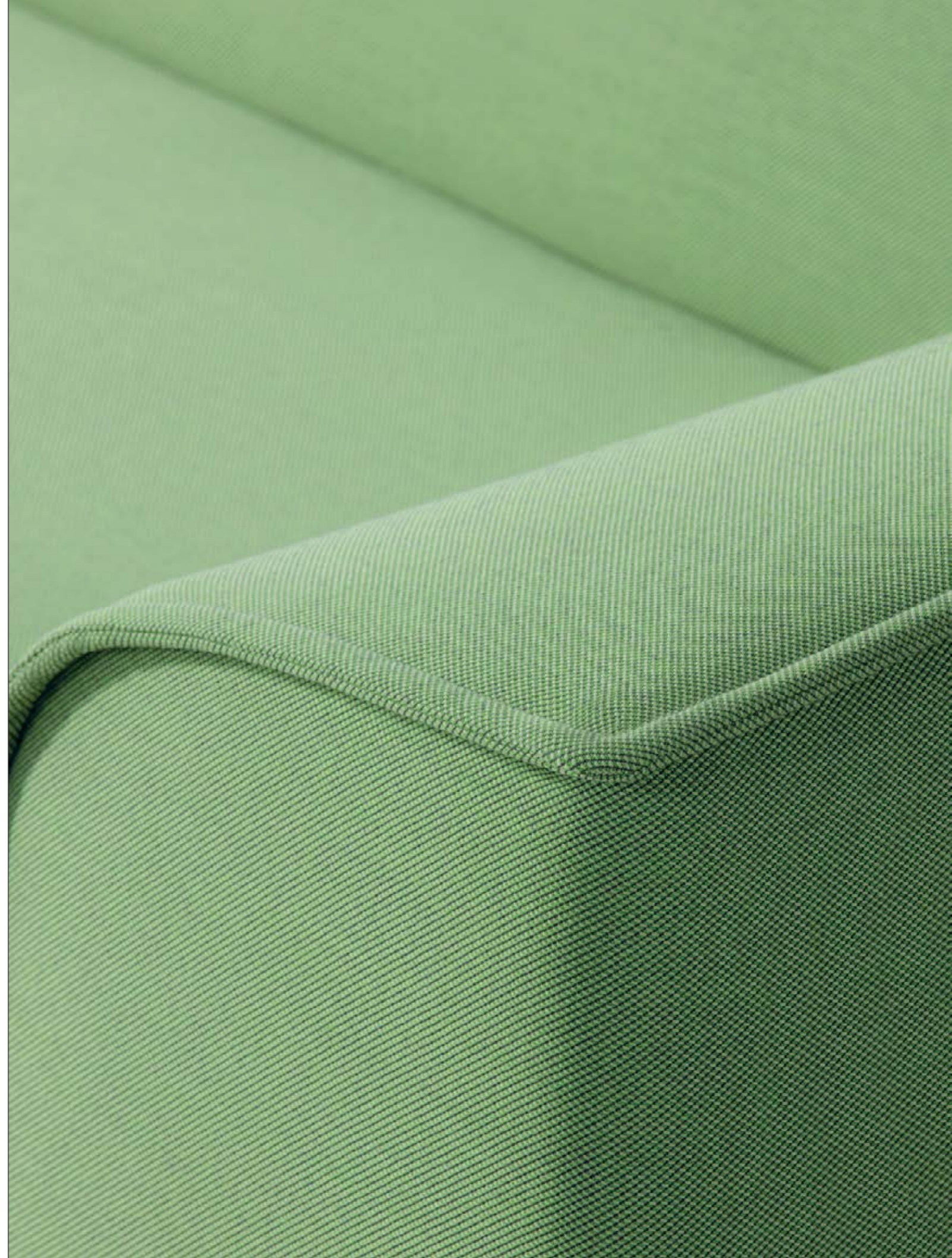





2 Seater Sofa / 3 Seater Sofa

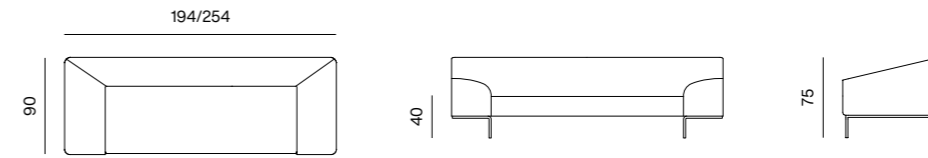

Corner Extended (L/R)

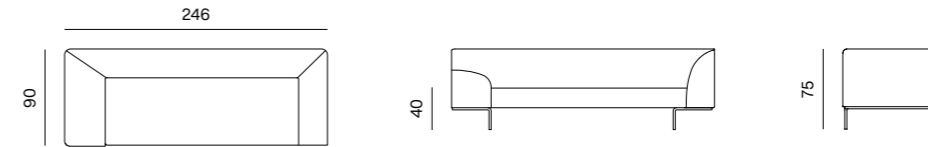

End Unit (L/R)

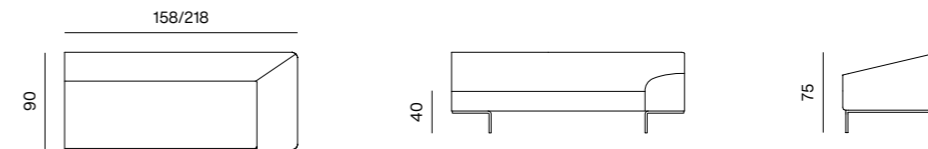

Chaise Longue (L/R)

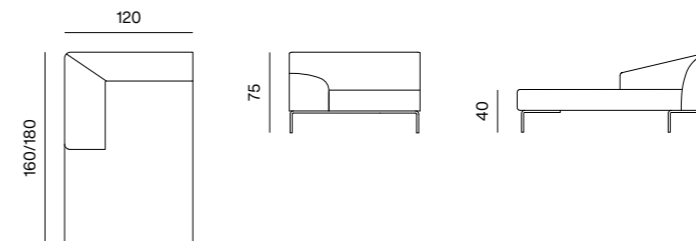

Pouf

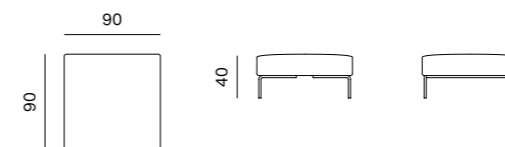

Revolve is a multifunctional sofa that unites seating and sleeping needs. Its design can make a grand statement in a room, and with just a smooth rotation of 180 degrees transforms sitting into sleeping. Revolve offers an optimal sleeping quality while its padding resembles self-standing mattresses made of high resilience foam. It thereby provides a quality sleep whichever part of the surface you choose to lie on — whether in the middle or at one of the sides. Thanks to its dynamic shape and dual function, it can be used in homes, offices and secondary residences.

Design: Numen / For Use, Ivana Borovnjak, Roberta Bratović

Revolve









3 Seater Sofa (Closed/Opened)

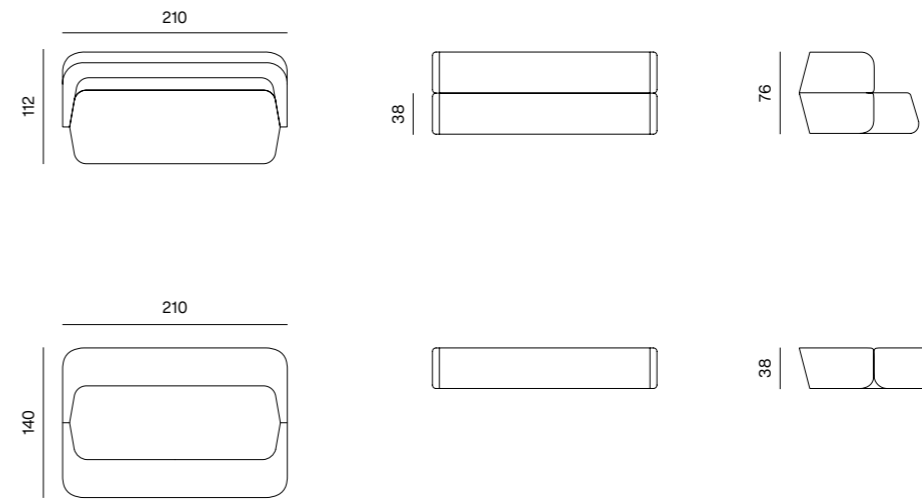

Pouf

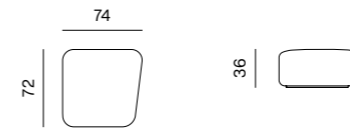

Up-lift represents innovation in a sofa typology with its integrated bed. Its shape allows for transformation through the simple raising of the backrest, which causes an automatic lift of the leg rest, whilst maintaining an optimal height. Sofa's harmonious form consists of two separate volumes, which rotate around each other in an eccentric fashion. The armrest is curved, as it also fulfils the function of a wheel, while the backrest is tilted and rounded to minimise the volume.

Design: Neisako

Up-lift







Armchair / Mattress

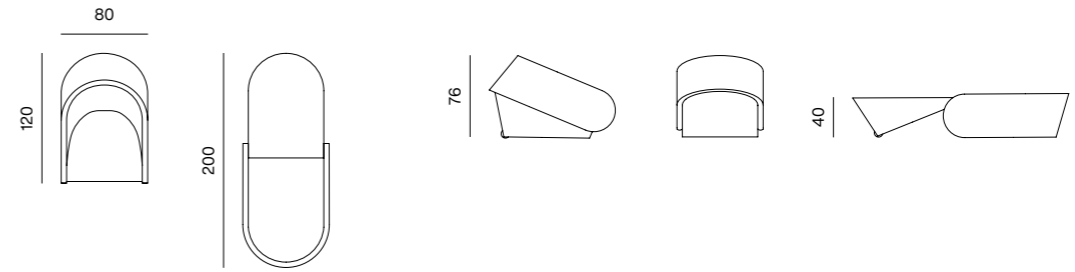

1.5 Seater / Mattress

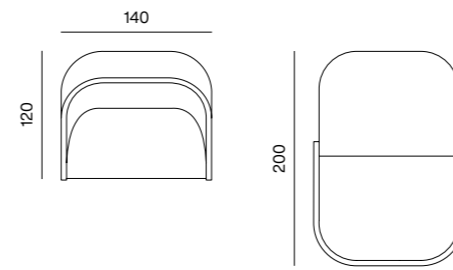

2 Seater / Mattress

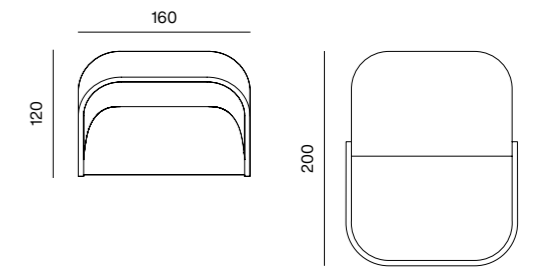

Pil-low transforms smoothly from a sofa into a bed. In the closed position, between the volume of the seat and the backrest there is a hard triangular pillow that adds to the quality of sitting. The sofa opens when entirely lifted forward and rotated around the sub-construction, hiding a space for storing bed linen. The backrest is then rotated backwards and the emerging gap is used for storing the pillow. With this system, all elements of the sofa are put to use as an expanded sleeping platform.

Design: Neisako

Pil-low

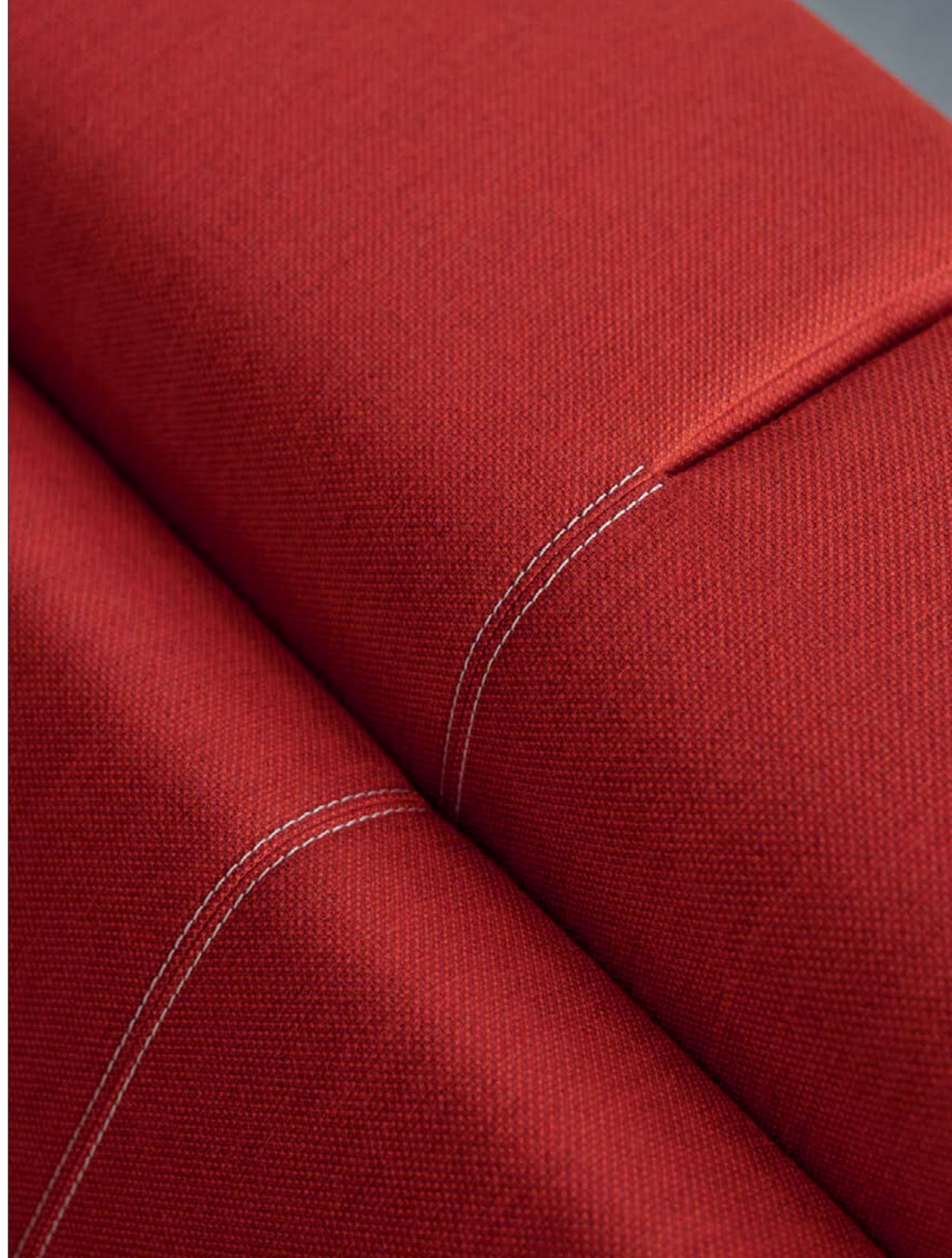



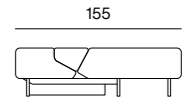
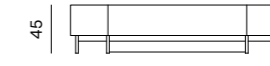
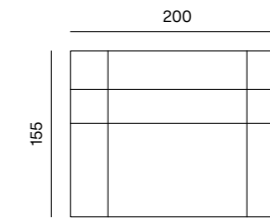
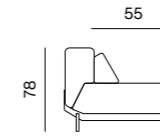
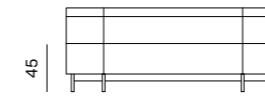
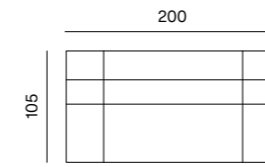

Bavul is a multifunctional upholstered object that transforms from a bench into a bed. In its basic form, Bavul serves as a seating system in a living room, dining room, or in a hallway — waiting to welcome your needs for an additional bed. Its dimensions are also a perfect match for hospitality projects where it saves precious space. With its strong visual appearance and combinations of colour, Bavul blends easily into a variety of interior styles.

Design: Lea Aviani

Bavul

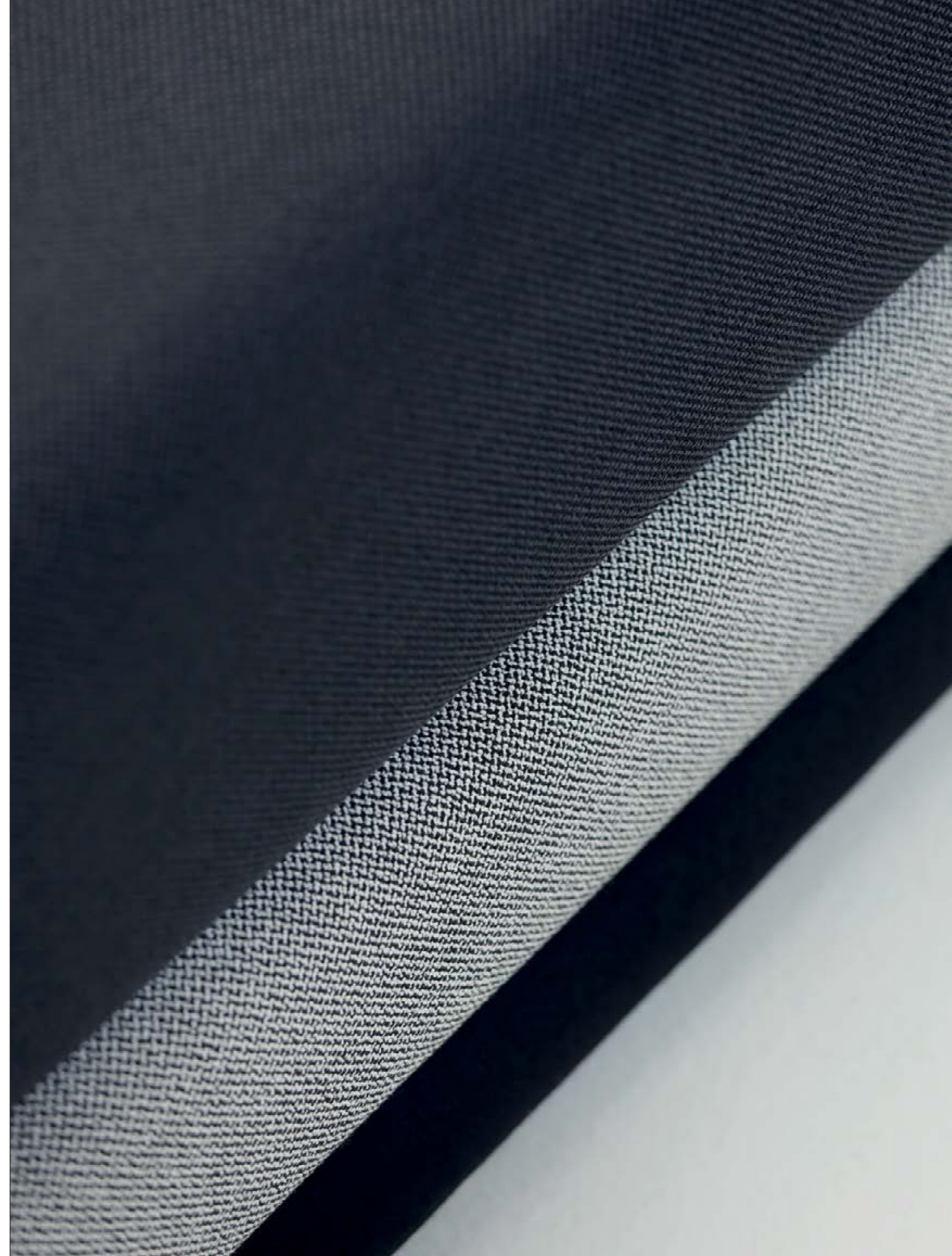



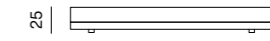
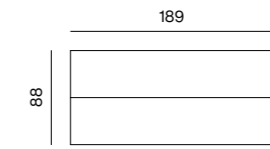
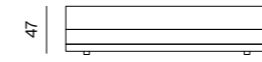
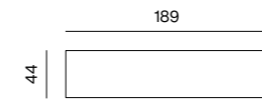

Fade is a sofa-bed collection featuring a characteristic, continuous diagonal bevel of edges, applied on all of the elements of the system. This formal fade-out of volumes, varying in depth or height, results in a soft transition of elements, uniting the cuboids of seat, backrest and armrests.

Design: Numen / For Use

Fade







2.5 Seater Sofa and Chaise Longue (L/R)

Mattress

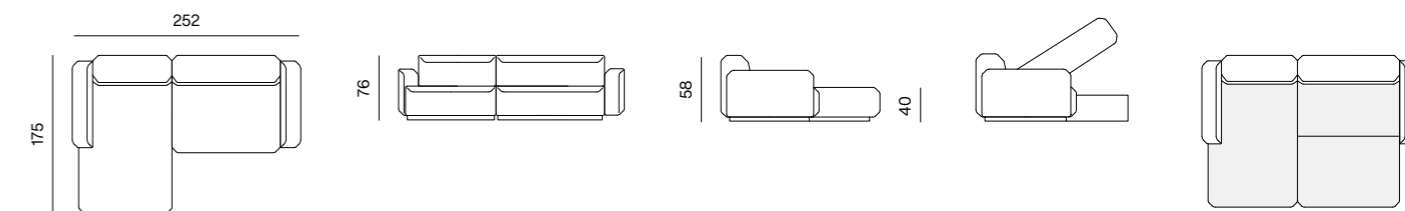

2.5 Seater Sofa and Chaise Longue (L/R)

Mattress

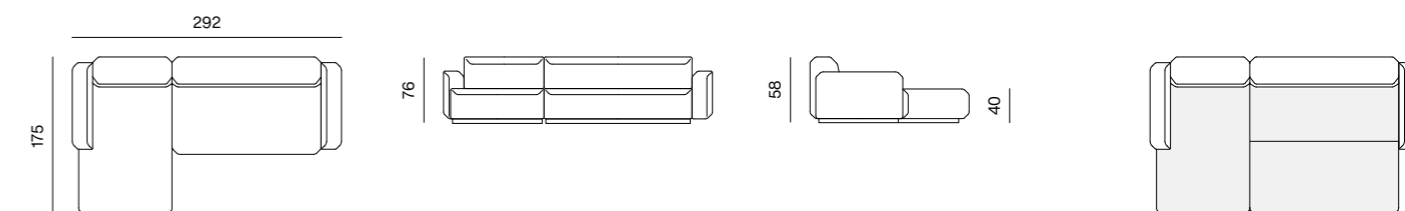

3 Seater Sofa

Mattress

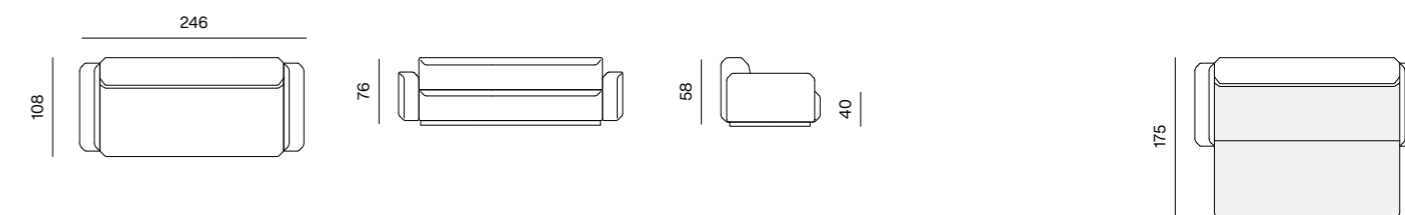

Being composed of a single element, i.e. massive oak sticks, Simetria was a challenging task for us, implying the quest for an expressive impression combined with the functionality derived from minimalistic means. The coat stand is symmetrical on both axis but its appearance changes depending on the perspective: from a serene mathematical sculpture to a vibrant and almost disorganised composition. Simetria is supremely practical: delivered in a flat pack, it is easy to assemble and features seamless joints. A relatively prosaic typology has been transposed into the pleasure of designing.

Design: Neisako

Simetria





Coat Stand

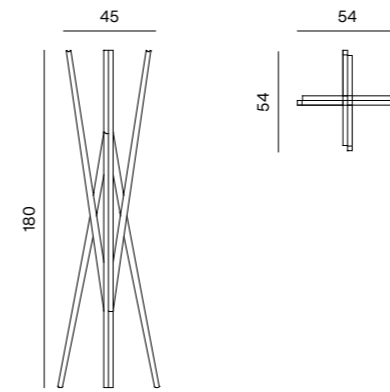

The basic structural module is a square that is applied on the wall as a visually autonomous object. However, to make the system adaptable to various ambiances and intended purposes, several modules with different proportions have been developed together with free-standing variants. L-cross-section shelves are inserted in the structural module; they come in seven different formats and can be used together with the rear part mounted upward or downward. Shtef is made out of aluminium to achieve lightweightness.

Design: 3LHD, Grupa

Shtef







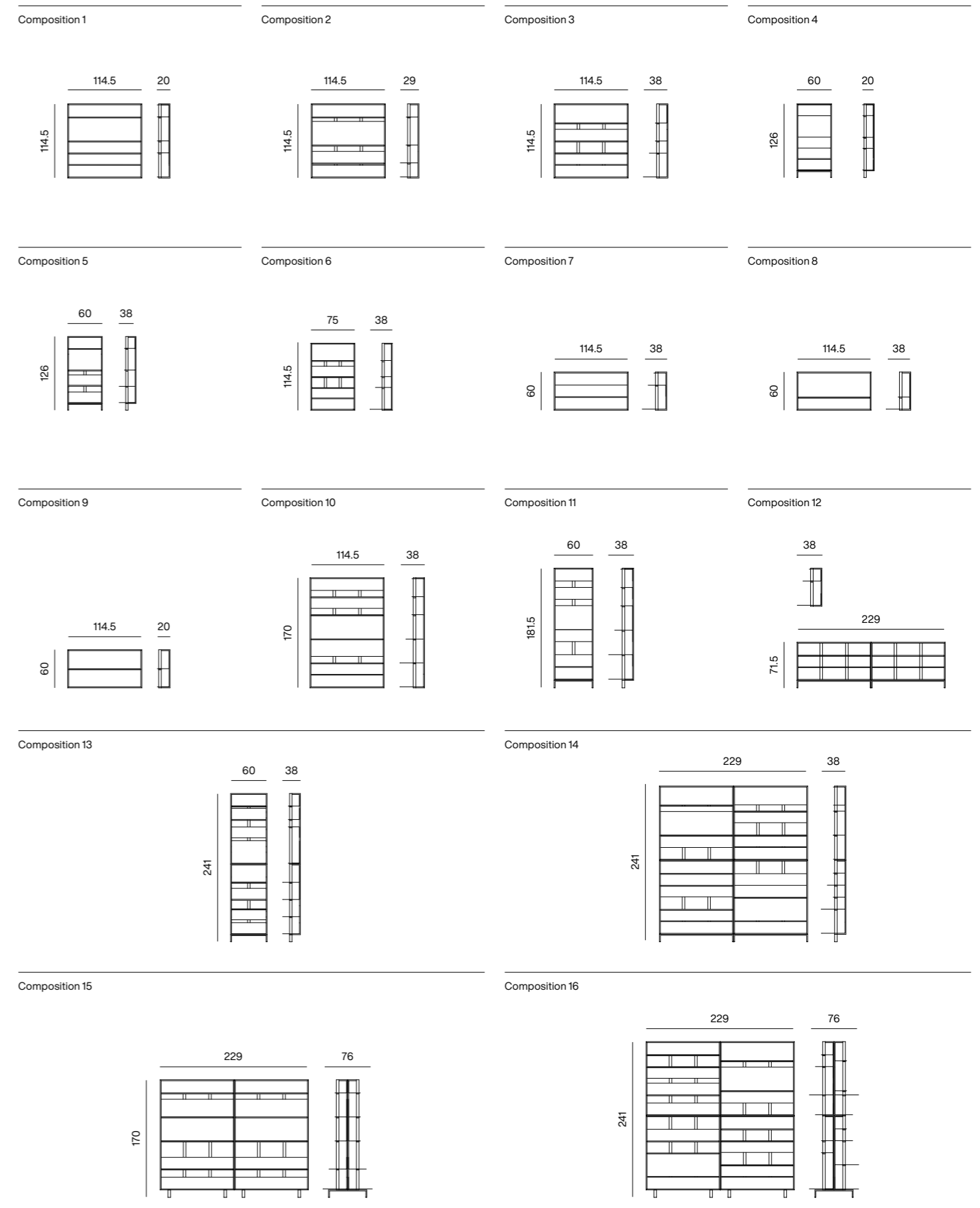
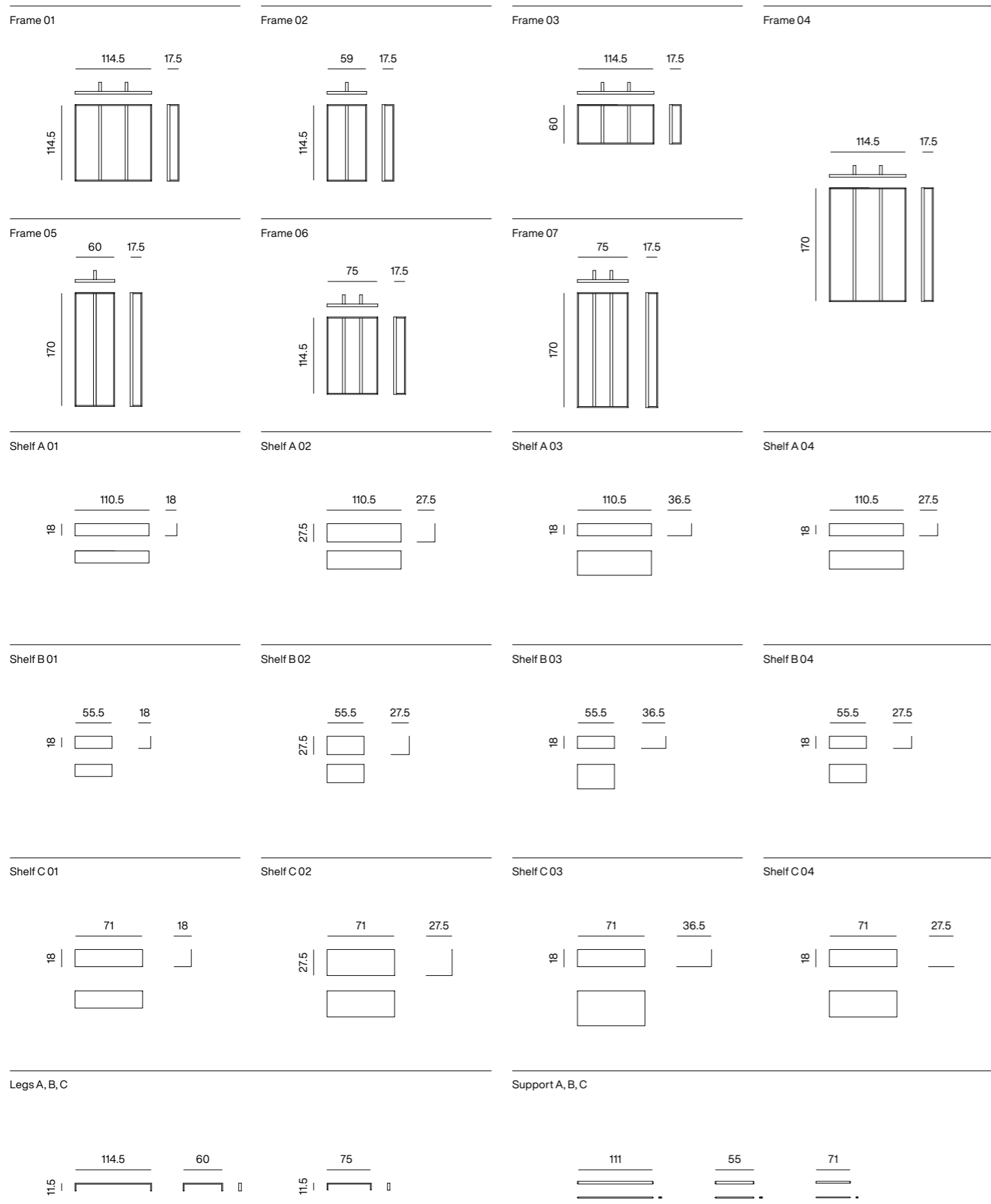

Knif is a modular shelving system catering for customised solutions and diverse user needs, and can be adapted to suit a multitude of interior-design concepts. Comprising a metal frame and solid wood shelves, it provides numerous combinations of height and width, all of which can be upgraded over time. With its light and low-key appearance, this sturdy structure sets the stage for a multiplicity of interior scenarios. The impressive depth of the shelves allows users to store or exhibit various objects.

Design: Studio RU:T

Knif



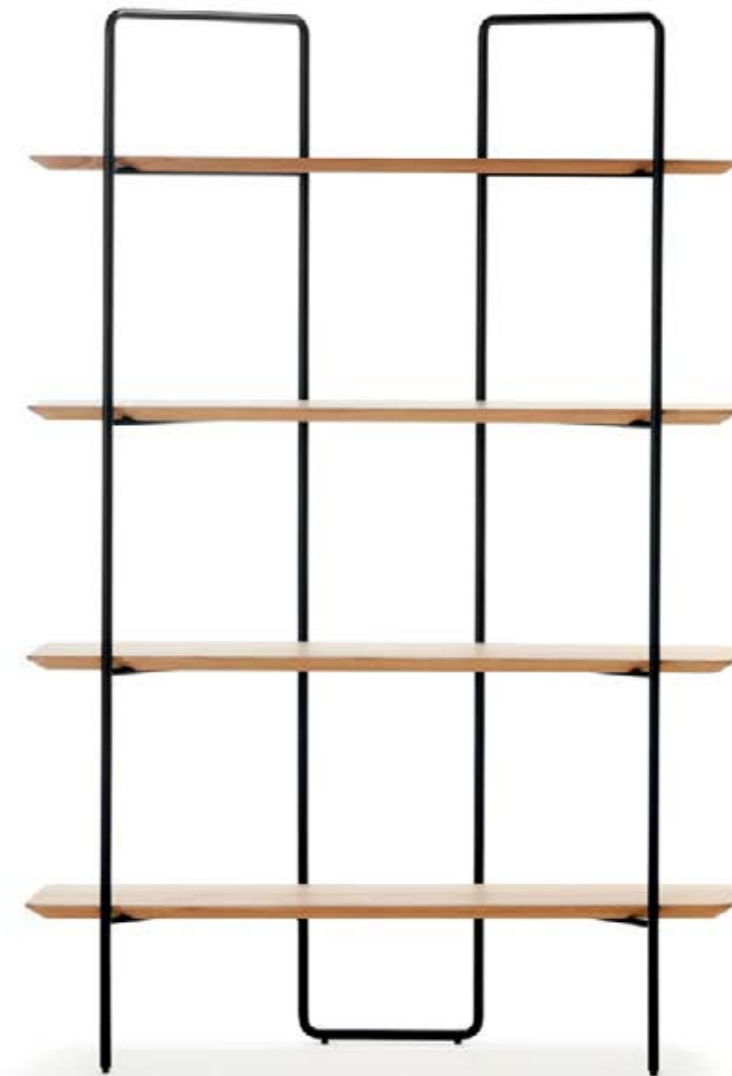

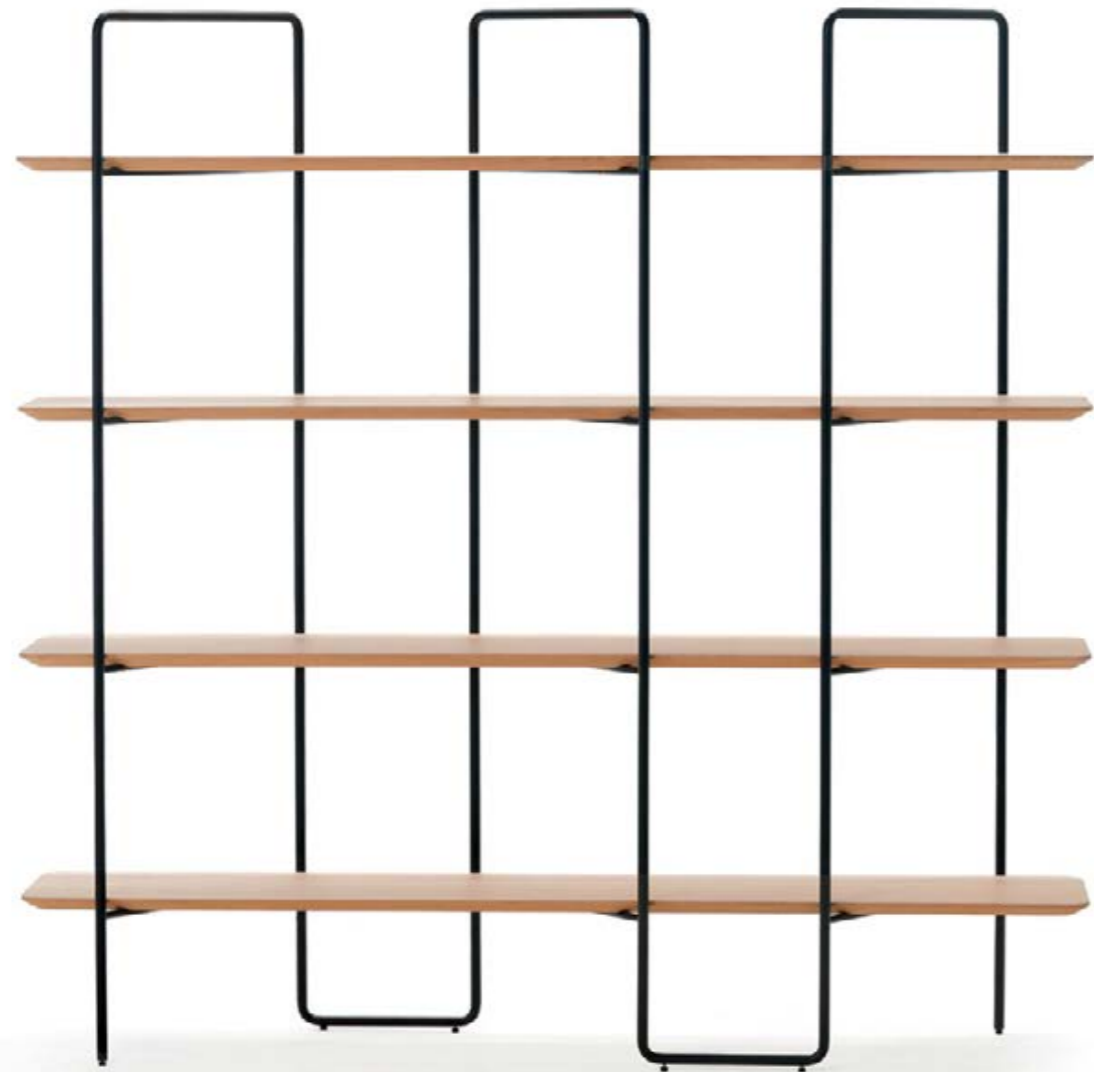

Frames L2 / L3 / L4 / L5

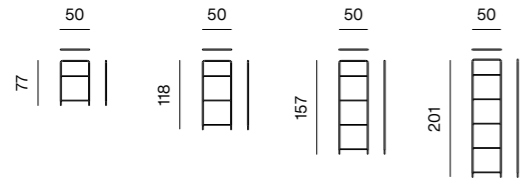

U Form / Leg (Set of 2)



Shelf P 120

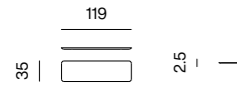

Shelf P 180

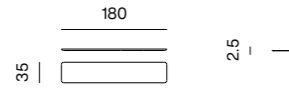

Shelf P 240

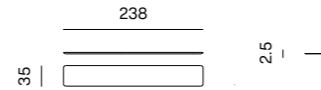

Basic Module 01 (2x2)

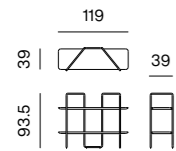

Basic Module 02 (2x3)

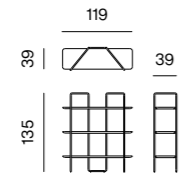

Basic Module 03 (2x4)

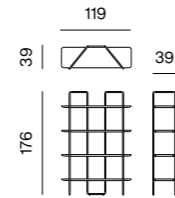

Basic Module 04 (3x2)

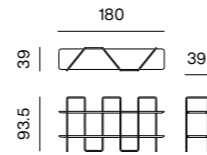

Basic Module 05 (3x3)

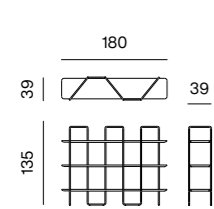

Basic Module 06 (3x4)

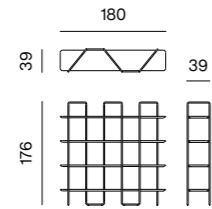

Basic Module 07 (4x2)

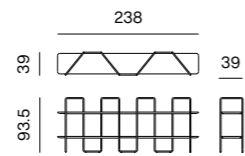

Basic Module 08 (4x3)

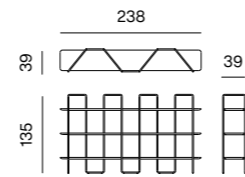

Basic Module 09 (4x4)

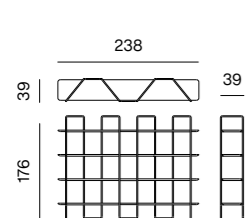

Basic Module 10 (2x5)

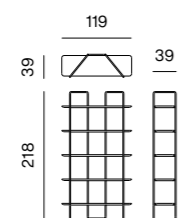

Basic Module 11 (3x5)

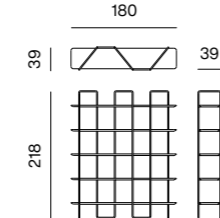

Basic Module 12 (4x5)

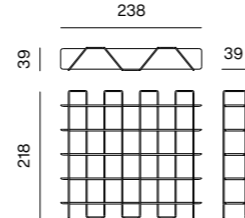

Modules 01+04+U

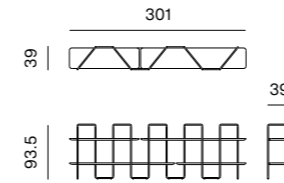

Modules 01+05+U

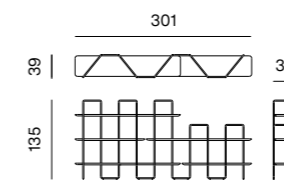

Modules 01+06+U

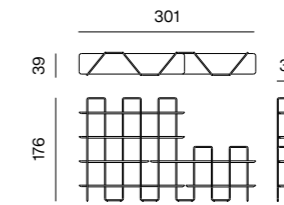

Modules 01+09+U

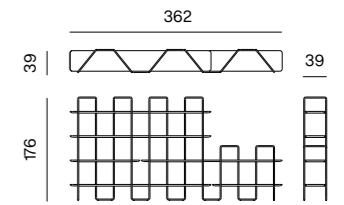

Modules 02+04+U

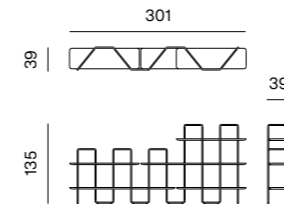

Modules 02+05+U

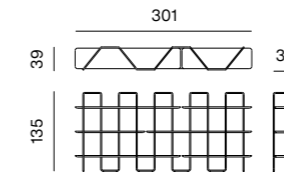

Modules 02+06+U

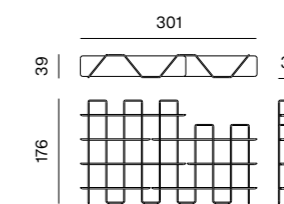

Modules 02+11+U

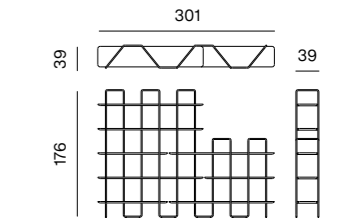

Modules 03+04+U

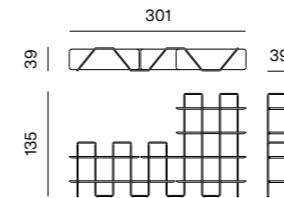

Modules 03+05+U

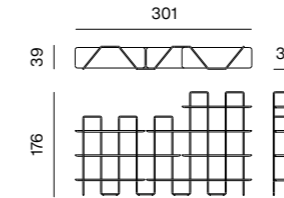

Modules 03+06+U

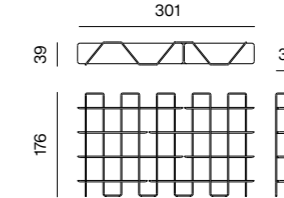

Modules 03+07+U

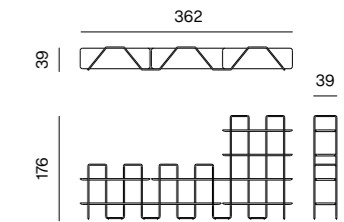

Modules 03+09+U

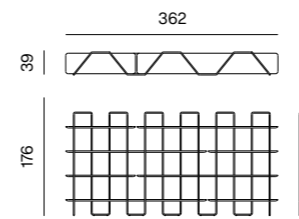

Modules 05+01+U

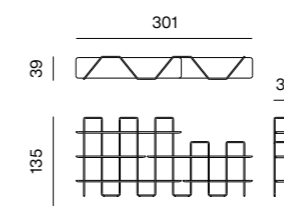

Modules 05+02+U

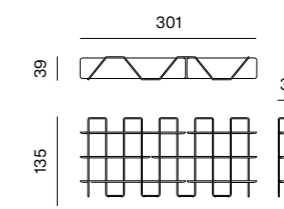

Modules 05+03+U

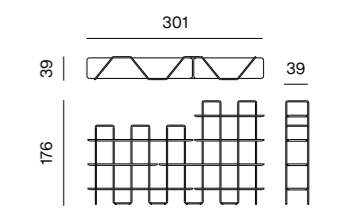

Modules 05+10+U

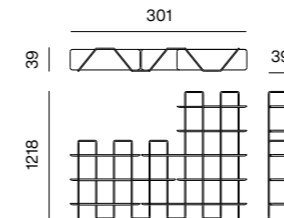

Chairs, Easy Chairs, Tables and Small Tables 264—395

Kontrapunkt is a design-led alternative to a traditional bulky recliner using electric motors to turn into a lounger. To transform Kontrapunkt, you simply need to raise an armrest and the armchair eases into a reclined position with a footrest that kicks out from under the seat. This simple transition is achieved with the innovative mechanism that is part of the design. The ergonomic shape and elasticity of the construction materials as well as different versions of the product's skin upholstered either in fabric or leather, result in great comfort.

Design: Neisako

Kontrapunkt







Recliner

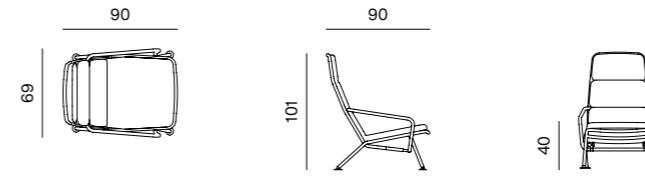

Recliner (Opened)

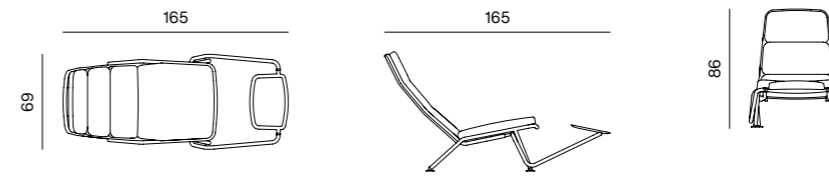

Polygon is an easy chair with highly graphic characteristics reminiscent of an architectural plan. The design is articulated as a series of separate elements connected by a bent tubular steel construction to meet all functional parameters and eliminate any bulkiness. The final result is a supremely comfortable and ergonomically efficient piece of furniture, which comes in both indoor and outdoor versions. The Polygon collection has been expanded to include low tables (also both indoor and outdoor) whose metal legs correspond perfectly to the overall design.

Design: Numen / For Use

Polygon









Easy Chair

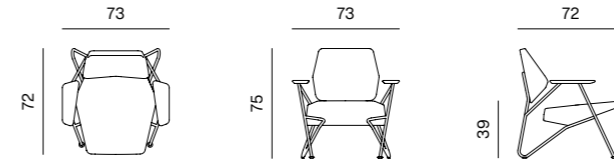

Low Table ø84

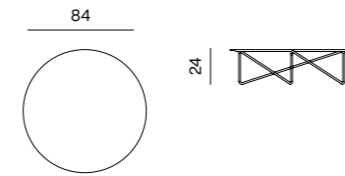

Low Table ø72

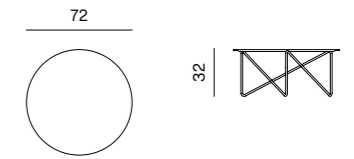

Low Table ø60

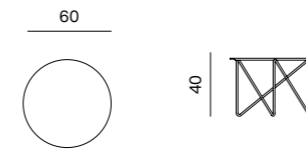

The Monk collection includes a chair, easy chair and a chair with the central swivel base (fixed or with castors). The chair's shell is composed of two bent pieces of plywood upholstered in fabric, with a simple structure made of massive wood or metal lying underneath. The armrest forms part of the seat and the whole shell appears to float independently of its relatively inconspicuous support. In addition to the basic barstool model, there is also a new version of Monk barstool and the counter stool available with the backrest upholstered in fabric. The collection also includes a dining room table, bench and low tables.

Design: Grupa

Monk















Easy Chair



Easy Chair, Metal Sled Base



Easy Chair, Metal Legs



Chair



Chair, Metal Sled Base



Chair, Metal Legs

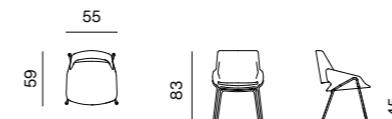

Chair with Swivel Base Fixed



Chair, Swivel Base with Castors



High Barstool



Low Barstool



High Chair, Metal Sled Base

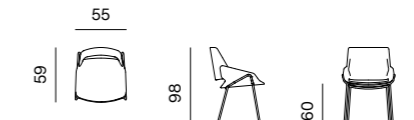

Low Barstool with Backrest, Metal Legs



High Barstool with Backrest, Metal Legs

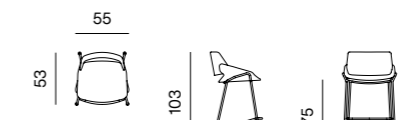

Low Barstool with Backrest, Metal Sled Base

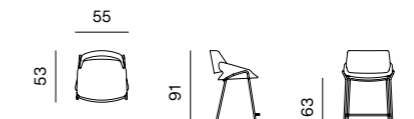

High Barstool with Backrest, Metal Sled Base

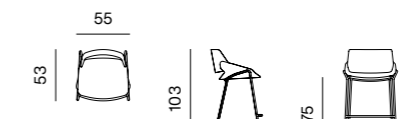

Low Table Midi

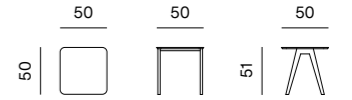

Low Table Mini



Table 100



Table

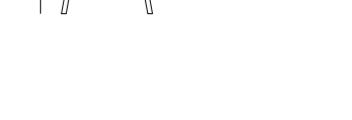

Table

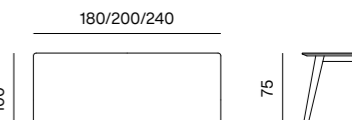

Table



Bench

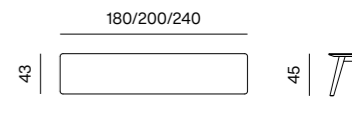

The Rhomb chair's organic shape is in opposition with the contemporary rhomboid geometry found in the cross section of the backrest and legs. Tactile and visual qualities of solid wood are accentuated owing to the combination of the state-of-the-art technology and sophisticated manual processing. Additionally, a table with rhomboid shaped legs was designed to match the chair. Its table top has a lens-like form and a sharp-knife edge, which creates its elegant flair, especially when made in lacquered finish with the Fenix top.

Design: Simon Morasi Piperčić

Rhomb









Chair

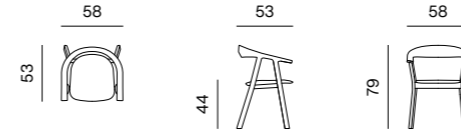

Chair with Cushion

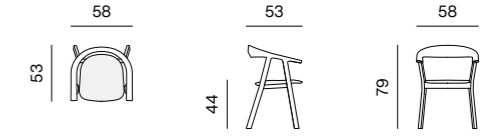

Table Square

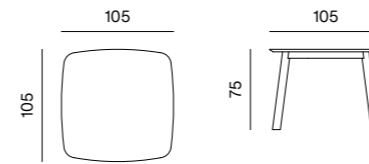
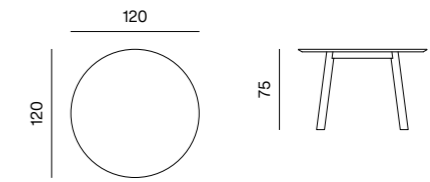
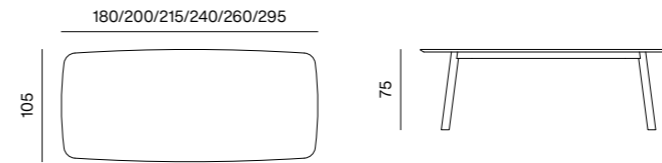

Table Round



Table



Designed to be inviting, Tinker is conducive to comfortable sitting and relaxed work by a mid-high table. Its form highlights the plywood backrest and the seat shell, upholstered in fabrics. In terms of typology, Tinker lies between a chair and an easy chair. Therefore, the seating cushion is intentionally softer, accentuating the feeling of cosiness and luxury, also achieved through its overall ergonomics. Slim steel legs keep the base “afloat” and they are available in various coating finishes.

Design: Grupa

Tinker

A close-up photograph of the Tinker chair. The image shows a dark, curved plywood backrest with a smooth, rounded edge. A thin, black, cylindrical metal leg is attached to the backrest with a small, dark, circular fastener. The leg curves downwards and outwards. The background is a plain, light-colored surface.



304



305

Tinker





Easy Chair

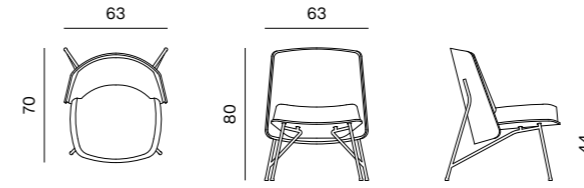

Low Table 50x50

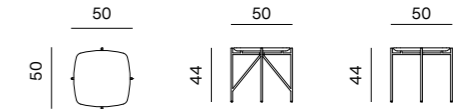

Low Table ø50

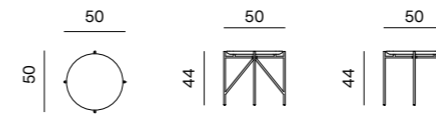

Low Table 70x70

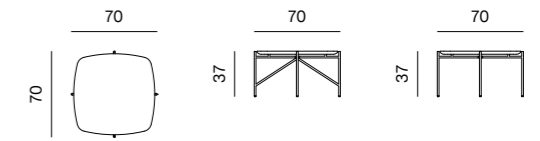

Low Table ø70

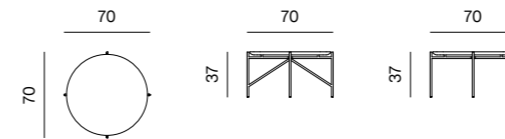

Low Table 90x60

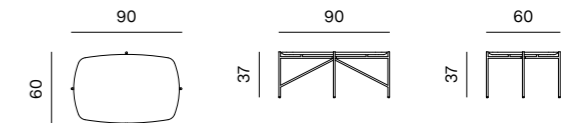

Low Table ø90, ø120

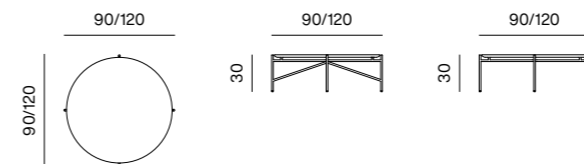

Low Table 90x90, 120x120

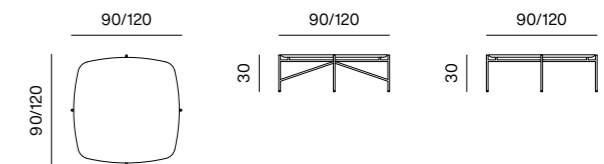

Toggle is an unpretentious armchair of small dimensions whose character entirely rests on the star-shaped composition of its profile. The three basic radial triangles of its structure extend into front legs and the armrest, providing an aesthetic and static balance to the chair. The removable cushions are attached to the wooden base by strip-shaped gussets connected by a cylindrical plug, or the Toggle. Depending on the treatment of the wood and the selection between wooden or steel front legs, the armchair changes its appearance, adapting to its various surroundings and purpose.

Design: Numen / For Use

Toggle







Armchair with Wooden Frame

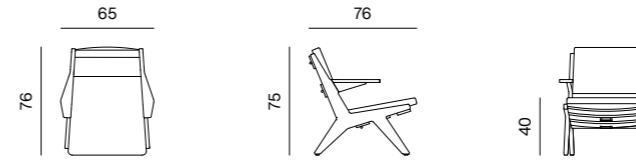

Armchair with Metal Frame

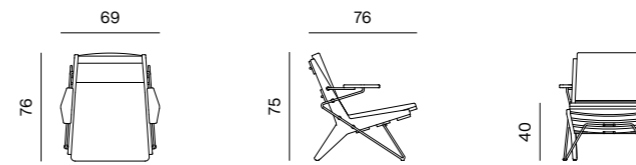

The Strain collection's distinctive character evolves from the particularly strained materials, the fusion of high-end technology and refined craftsmanship. The product family comprises an easy chair, a chair, a low chair, a bar stool and tables of various heights. However, the leg junctions are the main signature of its design language, achieved through the intertwined steel tubes which basically harden the whole construction. All Strain chairs can be upholstered with leather or fabric for superior comfort.

Design: Simon Morasi Piperčić

Strain





318



319

Strain



320



321



Strain







Easy Chair



Strain Chair



Strain Chair with Cushion



Strain Chair, Upholstered Seat



Strain Chair, Plywood Backrest & Upholstered Seat



Strain Chair, Plywood with Armrests



Unstrain Chair



Unstrain Chair with Cushion



Unstrain Chair, Upholstered Seat



Unstrain Chair, Plywood Backrest & Upholstered Seat



Unstrain Chair, Plywood, Armrests & Upholstered Seat



Strain Low Chair, Plywood



Strain Low Chair, Plywood with Armrests



Strain Low Chair, Plywood, Upholstered Seat



Strain Low Chair, Plywood, Armrests & Upholstered Seat

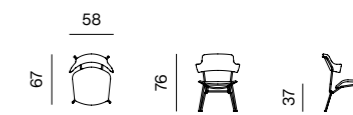

High Barstool

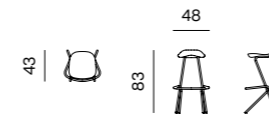

Low Bar Stool

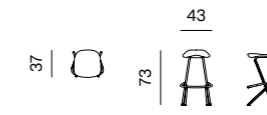

Stool

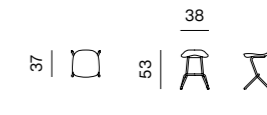
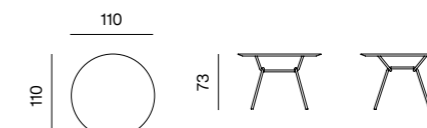

Table (Indoor/Outdoor)



Table (Indoor/Outdoor)



Low Table (Indoor/Outdoor)

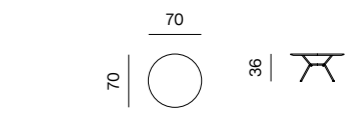
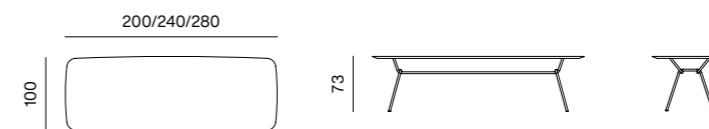
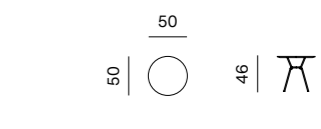

Table (Indoor/Outdoor)



Low Table



The Oblique collection provides a quality sitting experience within minimal dimensions. The profile underlines two triangular prisms. They ensure the greatest thickness of the foam on the major points of support for the body when sitting: the back side of the seat and the lumbar zone of the backrest. The narrowed plane where the volume from the seat blends into the backrest improves the ergonomics, but also allows for the elasticity of the backrest. The top of the legs has a rectangular cross-section, but becomes increasingly thin towards the bottom, turning ultimately into a triangular base. The collection also comprises of a large dining table and low tables.

Design: Numen / For Use

Oblique





330



331

Oblique





334



335

Oblique





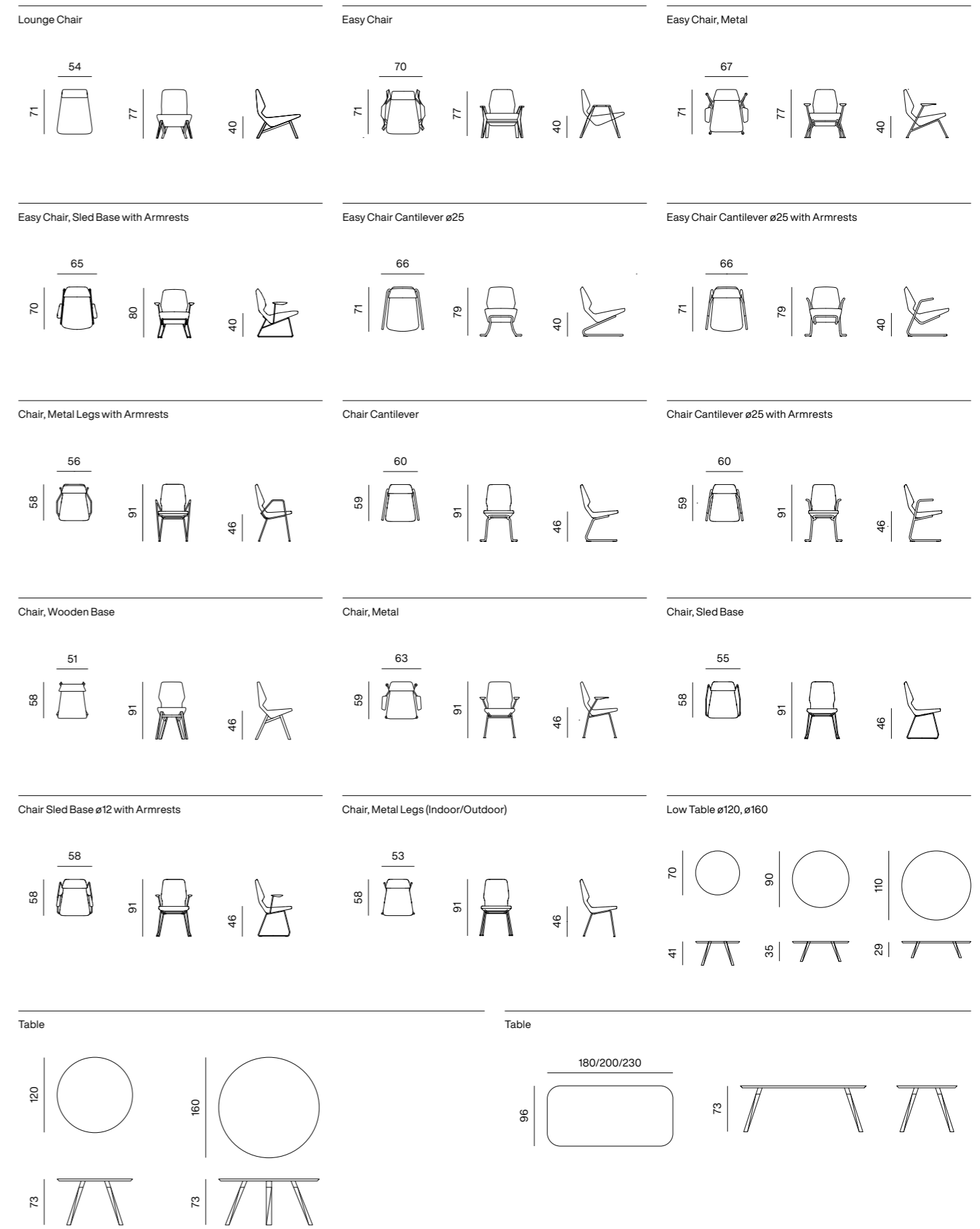

Oblikant is a derivation of the Oblique family. Regardless of different technology and typology from its upholstered siblings, Oblikant retains the characteristic S-shaped profile of the chair. Strong curvature of the shell provides quality ergonomics which is further highlighted by the elasticity obtained from the geometry. The shell is made of 2D moulded plywood, combined with six versions of steel legs of which four are stackable, and one is a solid wood base.

Design: Numen / For Use

Oblikant







346



347

Oblikant



Chair



Chair Cantilever

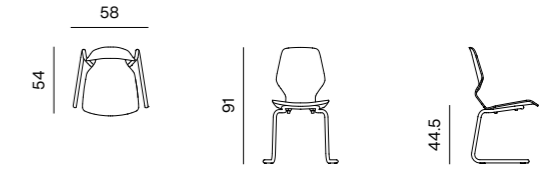

Chair, Sled Base



Chair Cantilever with Armrests

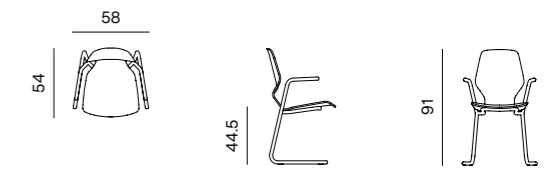

Chair, Sled Base with Armrest

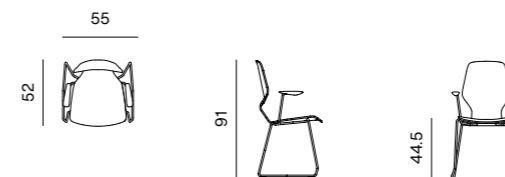

Chair, Metal Legs

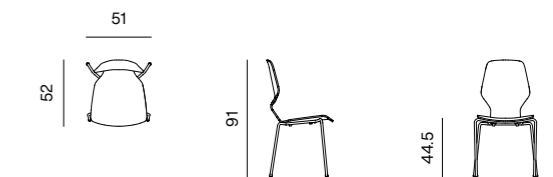

Chair, Metal Legs with Armrests

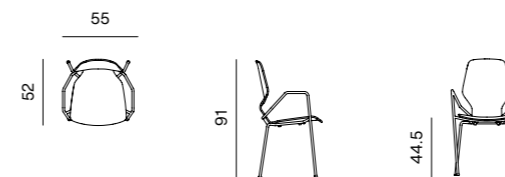

With its airy flair, the design of the Piun chair revolves around lightness, functionality and comfort, which are all necessary for a dining setting. The challenge was to design a light and stackable chair with armrests for mass seating. Additionally, Piun is quite slim, a functionality that allows placing more chairs around the table, without overcrowding the area. Its metal body carries the expression of an embrace, enveloping the wooden backrest. At first Piun was designed as a monochromatic compound of form and colour, but it is now available in various combinations.

Design: Grupa

Piun





352



353

Piun





356



357



Piun



Chair

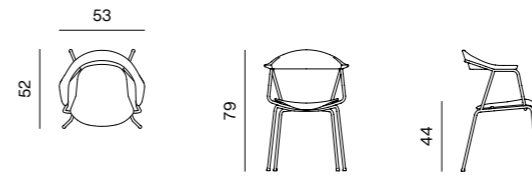

Chair Upholstered Seat

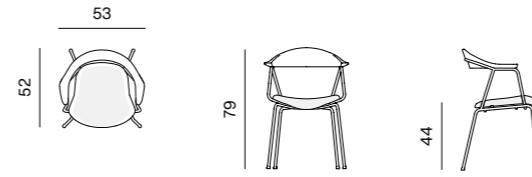

Trifidae are a collection of seats that includes three different armchairs and one chair. Consisting of three separate parts, a small easy chair, a high backrest armchair, a lounge chair and a chair all share the same triangulated form with the focal point in the central part, embracing the user's lumbar area and functioning as an armrest. The tilting of the three parts of the armchairs resembles closing and openings of the petals of flower buds.

Design: Numen / For Use

Trifidae







364



365



Trifidae



Lounge Chair, Wooden Base



Lounge Chair

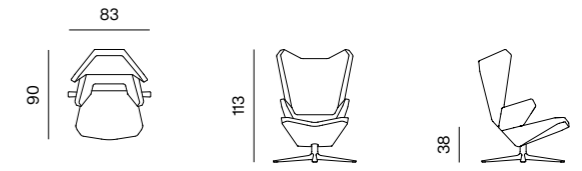

Armchair, Wooden Base

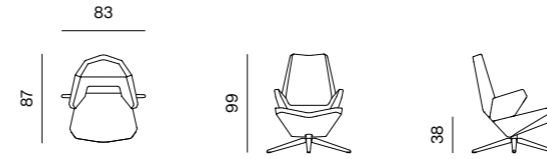

Armchair, Metal

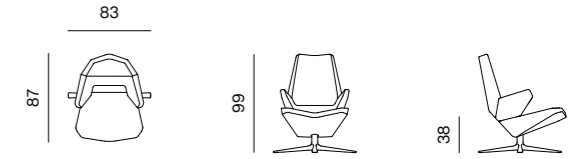

Pouf



Easy Chair



Conference Chair

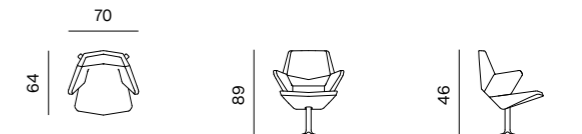

Low Table

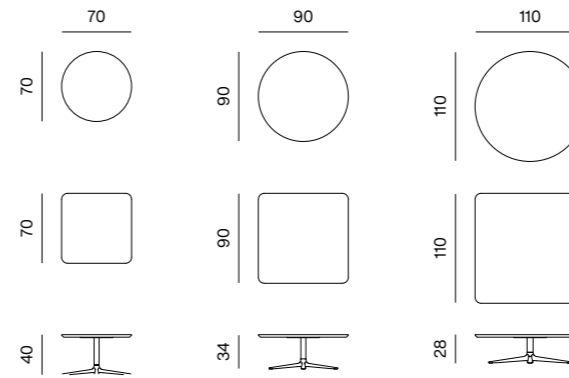

Table

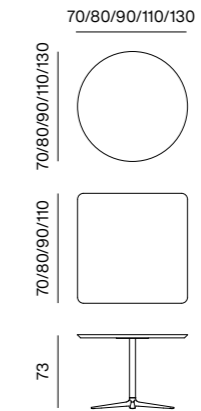

Bar Table

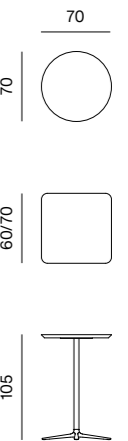

Dobra is a solid wood chair which was originally supposed to be called Sunday, as it was inspired by easy-going Sunday mood. The traditional typology of a wooden chair with armrests was reinterpreted by the application of a characteristic 'break' in the geometry of the front legs. Dobra's graceful solid-wood design owes its unique fragile flair to the thin and super-light body of the chair. Dobra provides firm and stable support in a sitting position due to the rounded geometry of its backrest and armrests resulting in ergonomics that trigger a sense of comfort.

Design: Numen / For Use

Dobra





370



371



Dobra





Chair

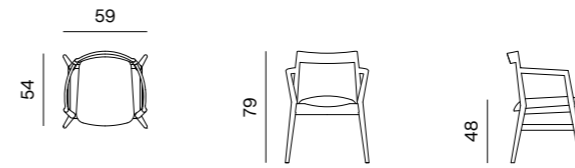

Easy Chair

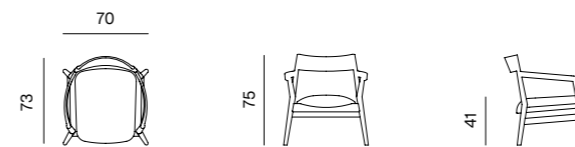

Bik is a chair reduced to its basic elements: four legs, seat and a backrest. The barely visible tapering of the legs, the frontward inclination of the back legs and the slightly overstated curvature of the backrest define the individuality and character of this, otherwise archetypal, chair. Wider back legs are slightly detached aside enabling easy stacking when chairs are not in use. The structure is made of solid wood, while the seat and the backrest are made of moulded plywood.

Design: Numen / For Use

Bik







Chair with Long Backrest

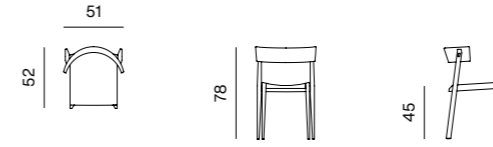

Chair with Short Backrest

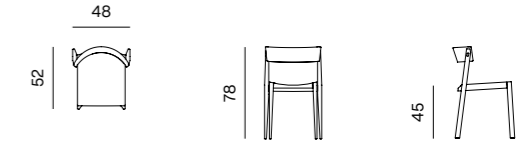

Chair with Long Backrest and Upholstered Seat

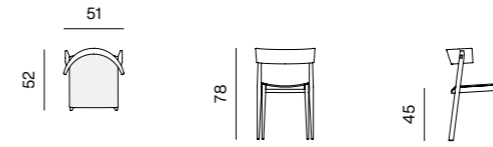

Chair with Short Backrest and Upholstered Seat

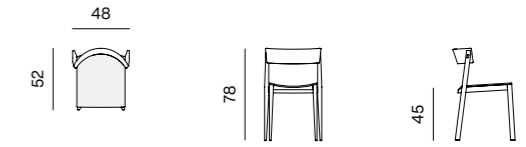

Chair with Long Backrest and Cushion

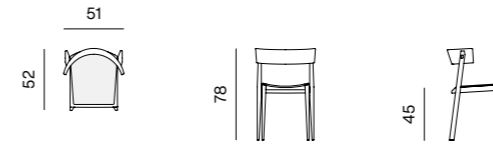

Chair with Short Backrest and Upholstered Seat

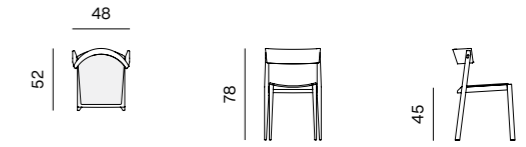

Design of the 3angle armchair and two-seater sofa follows fragmented, crystal-like forms systematically describing a compact volume, almost like an algorithm. This solution is not only formal — the characteristic 3angle armrests follow the ergonomic line of relaxed arms. A soft shell of the backrest and armrest is covered with a continuous cover whose edges are marked only with a very subtle line of seams. A light metal sub-construction reproduces the characteristic triangular motif contributing to the compactness of the composition.

Design: Grupa

3angle





384



385

3angle



Armchair

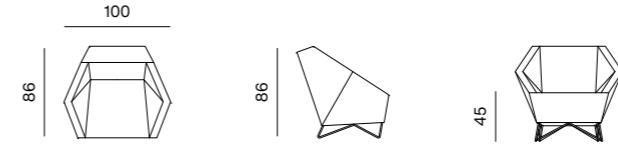

2 Seater Sofa

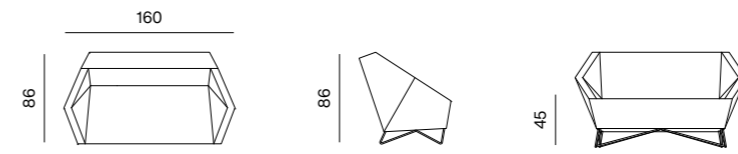

Pouf

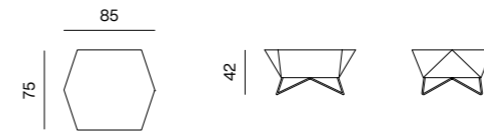

The design of the Avet low table relies on the light triangular metal construction, whose skeletal lines endow it with a certain fragility and weightlessness. With the addition of its toned glass surface, the table becomes almost dematerialised, an elegant, shadowy silhouette.

Design: Numen / For Use



Avet



Low Table 50

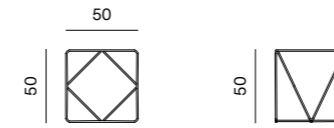

Low Table 90/120

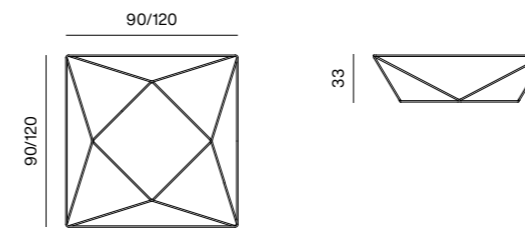

The Frame collection is a family of transparent low tables that can be used as stand-alone pieces, or arranged in series within a given framework. The height of the arrangement is determined by each table's use as either a main or a side table. The frame is made of a metal profile with a glass or compact panel placed on top.

The Frameless collection is a member of the Frame family of low tables. The only difference between them is in the thickness of the metal frame. As the name suggests, Frameless is a uniquely lightweight object, thanks to its slender metal frame. Each table can be used to stand alone or to be arranged in a series. The height is determined by a table's use as the main or side table. Each table's frame consists of a metal profile with a glass or compact panel placed on top.

Design: Sanja Knezović

Frame + Frameless





Frame + Frameless Low Table 1/2

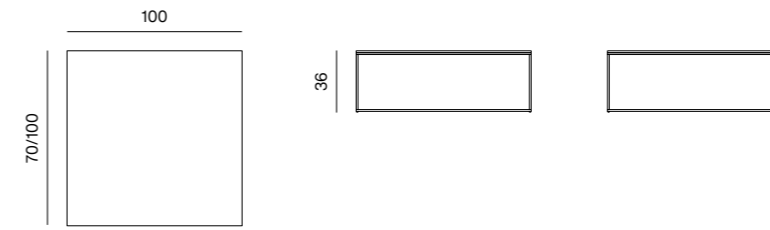

Frame + Frameless Low Table 3/4

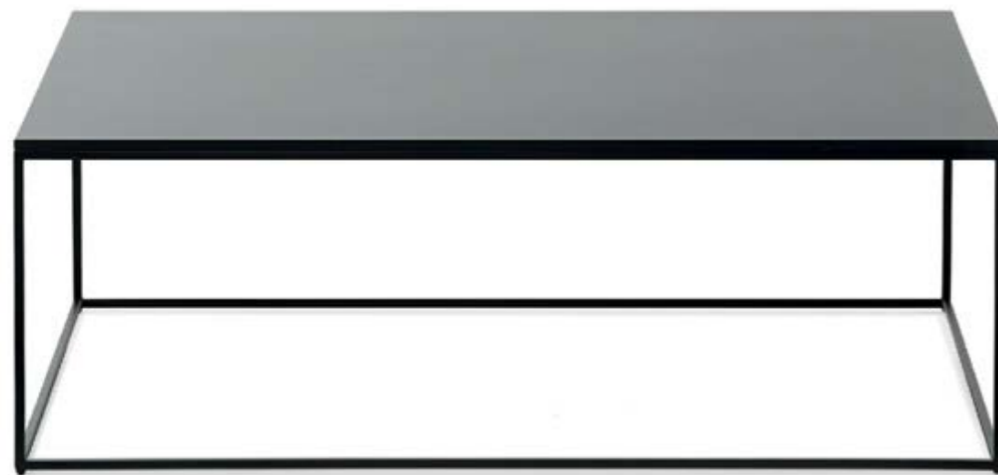
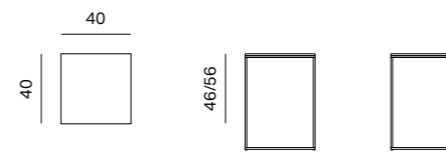

Frame + Frameless Low Table 5/6

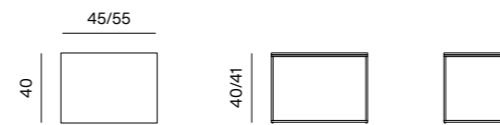

Outdoor 396—439

The Umomoku collection consists of a chair, two-seater and three-seater settees, a sun lounger, a coffee table and a tray, all of which are designed to serve as a private oasis of hedonism in an outdoor area such as the large terrace of a hotel or villa. The elementary design of the series is evident in the wooden structure and the slats on the back of each of the seating elements, although the addition of sumptuous cushions evokes extreme comfort. The sun lounger is particularly functional as it allows easy handling of the backrest on both sides, providing for a variety of uses. Next to the headboard, there is an extension made of slats for storing drinks and treats.

Design: 3LHD

Umomoku











Armchair

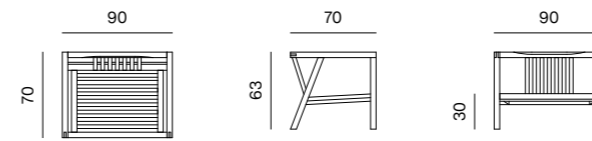

Low Table

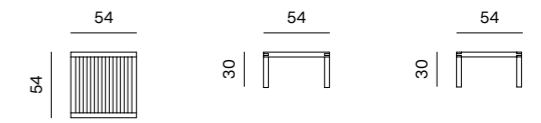

Bench

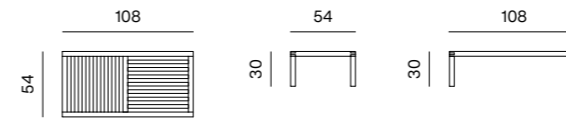

2 Seater

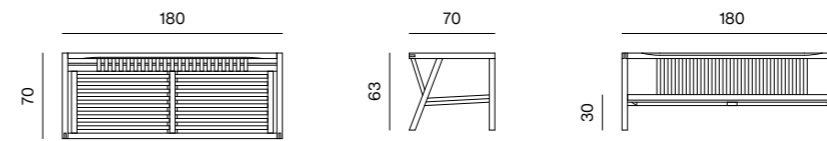

3 Seater

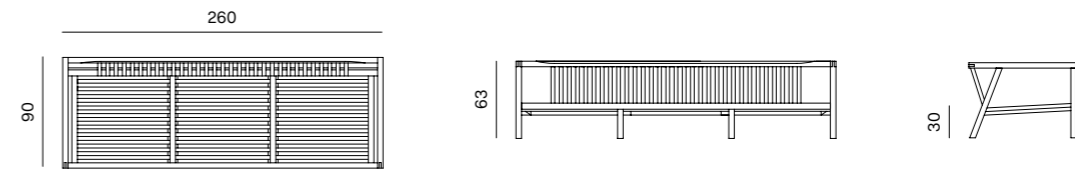

Sunlounger

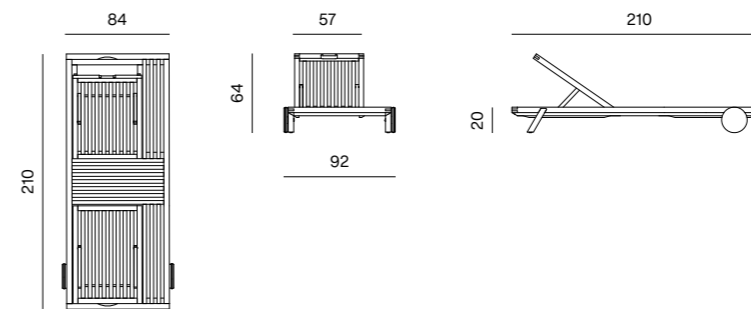

Osmo is a series of furnishings designed according to the classic typology of chairs intended for use on the terraces of hotels and restaurants. The steel framework, combined with a wooden seat and a backrest, provides an optimal equilibrium of comfort and rigidity exactly in line with the demanding context of extensive use in exteriors exposed to sun and sea air. A bent-tube structure defines the frame into which the wooden slats of the seat and backrest are inserted. The characteristic inclination of the front legs, combined with an extremely wide, uneven armrest, results in a quirky biomorphic appearance reminiscent of an insectoid robot from a science fiction film.

Design: Numen / For Use

Osmo







412



413

Osmo



Easy Chair



Easy Chair with Armrests



Chair

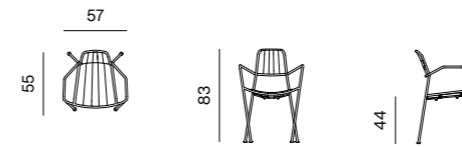

Chair (Steel or Inox)

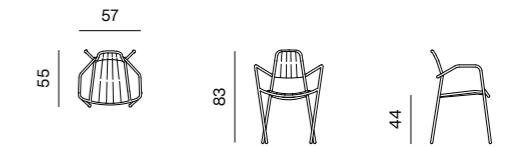

Easy Chair with Wood (Steel or Inox)



An extremely delicate tin surface creates a transparent frontal view, while the side view clearly reveals the form and function of the birdhouse. Minimalist design has breathed new life into this otherwise marginalised object by expanding its primary function into a decorative one.

Design: Filip Gordon Frank

Coo Coo

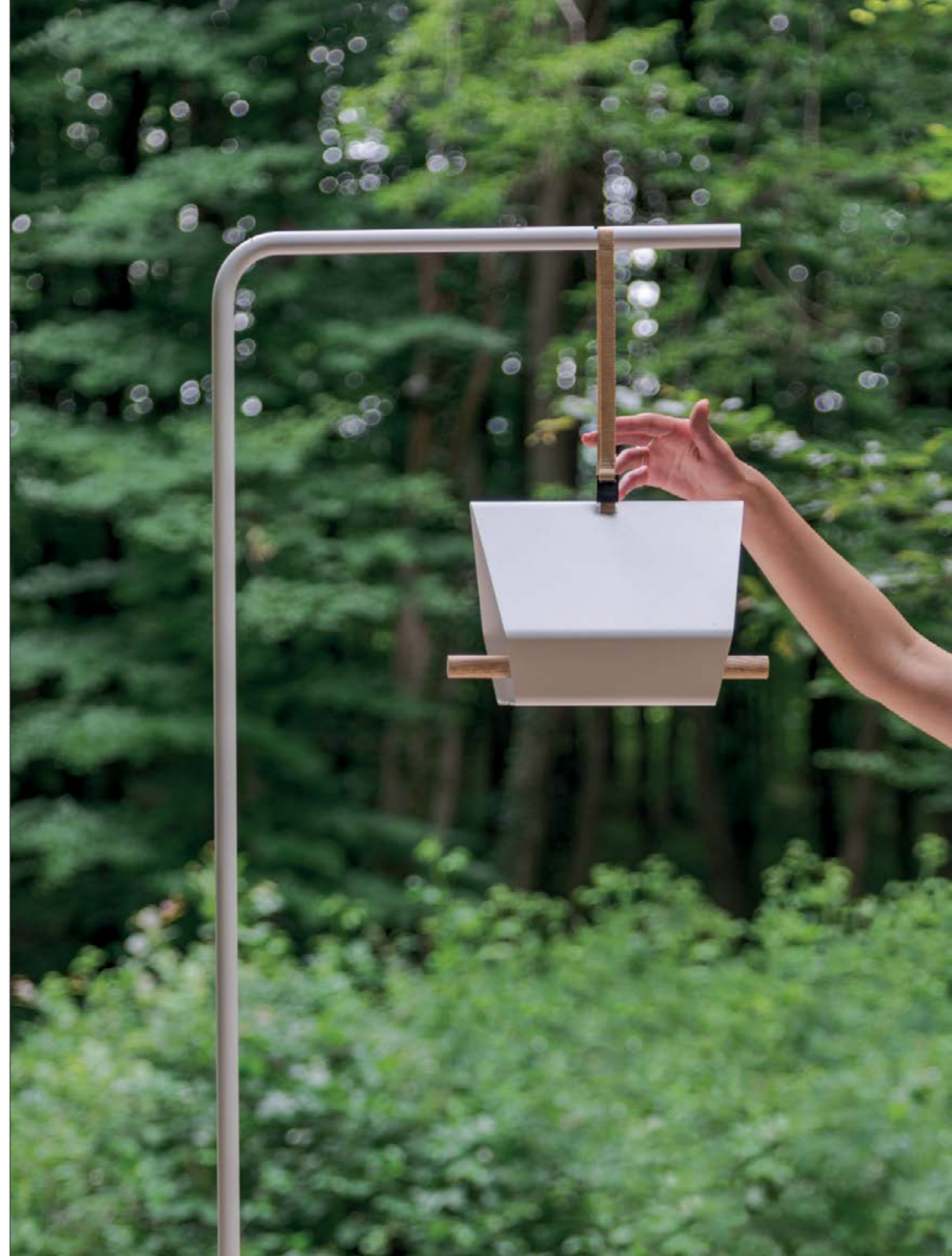



Birdhouse

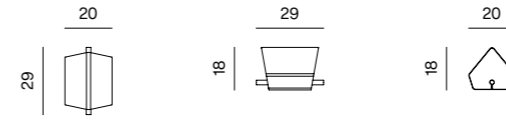

Stand S / Stand M / Stand L

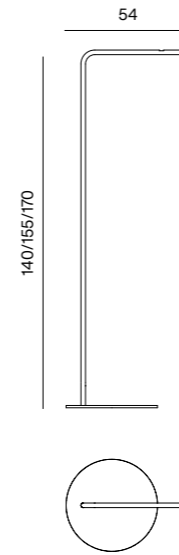

The Jugo outdoor collection is designed to evoke the laid-back spirit of the Mediterranean, and the appetite for relaxation and hedonism it brings to mind. The collection is designed to create a contrast between the rational form of the stainless steel frame with the oversized wooden armrests and plush cushions. The seat and the backrest are inclined at an angle that ensures a high level of ergonomic efficiency in the seating position. The solid wood armrests of both the Jugo easy chair and the sun lounger are characteristically wide. Their width almost matches the dimensions of the tray tables that can be used for holding a glass of wine or other favourite drink. This feature imbues the easy chair with a specific character that is both practical and lavish at the same time. All of the surfaces of the tables and low tables are made from wooden and metal slates, chosen for their durability and their ability to mature gracefully. The distinctly accentuated discs at the base of each chair leg are another characteristic design feature, whose function is to ensure that the chair can also be used on soft or sandy surfaces. The name of the collection is inspired by the “Jugo” or “Southerly”, the moisture-bearing wind typical to Dalmatia which blows in from the southeast, coming over the islands and on towards the mainland.

Design: Numen / For Use

Jugo









Sunlounger

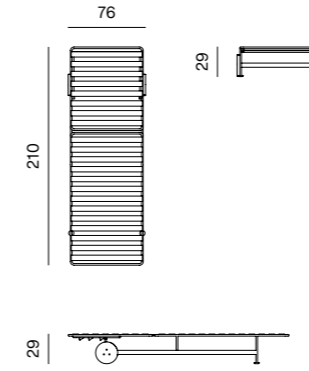

Sunlounger with Armrests

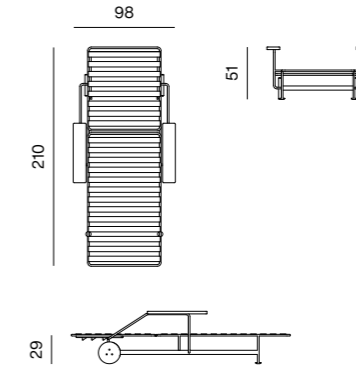

Sunlounger with Armrest (L/R)

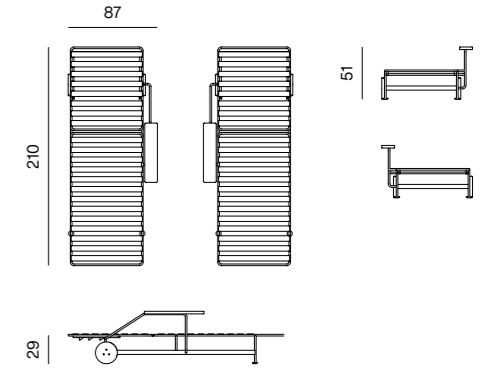

Chair

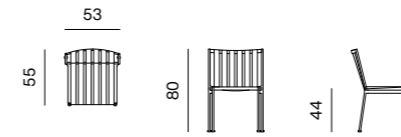

Barstool

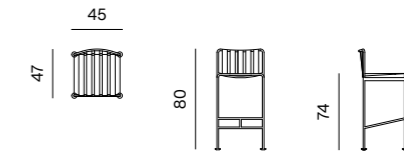

Chair with Metal Armrests

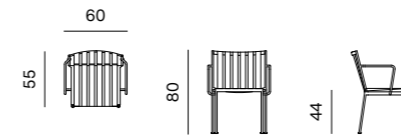

Chair with Wooden Armrests

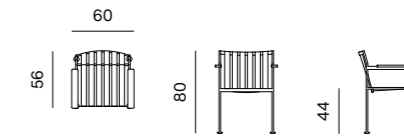

Armchair

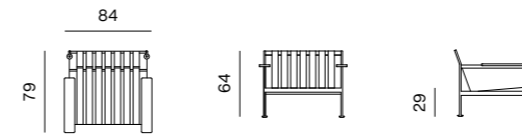

3 Seater

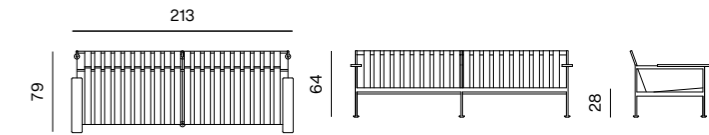

Lounge Armchair

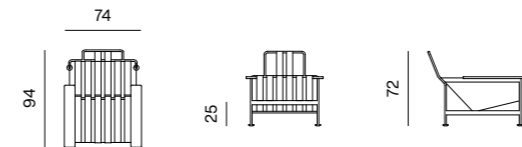

Side Table

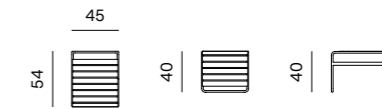

Low Table

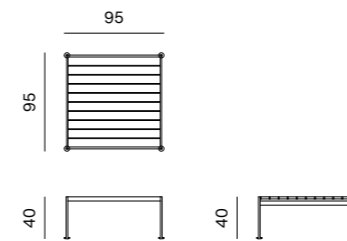

Table 80x80

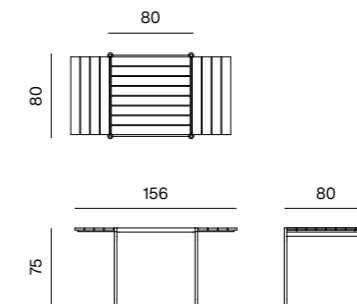

Table Extension (Optional)



Table 140x80

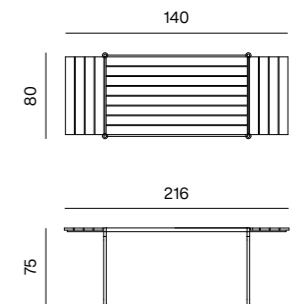

Table Extension (Optional)



Polygon outdoor shares the same design features as its indoor version. It is produced from materials suitable for extensive use in the exterior exposed to sun and seawater. The collection has been expanded with the addition of low tables whose metal legs fit in perfectly with the overall design.

Design: Numen / For Use

Polygon





430



431

Polygon

The Strain outdoor tables and low tables share the same formal origin with the Strain indoor collection. Interweaving steel tubes make an elegant base to a thin looking table top made either with Fenix NTM finishing, in MDF with lacquered edges or HPL compact for outdoor use. The tables are available in various sizes and can fit different types of chairs.

Design: Simon Morasi Piperčić

Strain





434



435

Strain

Oblique outdoor shares the same design features as its indoor version. It is produced in the materials suitable for extensive use in the exterior exposed to sun and seawater.

Design: Numen / For Use

Oblique





438



439

Oblique

**Designers 440—
443**



Numen / For Use

Numen / For Use is a design collective led by product designers Sven Jonke, Christoph Katzler and Nikola Radeljković. Over the past 20 years, Numen / For Use has been active globally in the fields of industrial and spatial design, scenography and conceptual art. It nourishes very rational aesthetics that could be categorized as functional minimalism. For Prostorija, Numen / For Use have designed the Polygon, Oblique and Trifidae easy chairs, Oblikant, Bik, Dobra and Osmo chairs, Revolve, Layout, Absent, Segment, Combine and Fade sofas and the Jugo outdoor collection.



3LHD

3LHD is an acclaimed architectural practice that integrates architecture, art and (urban) landscape. Their projects, such as the Memorial Bridge in Rijeka, Riva Waterfront in Split, Spaladium Center, Hotel Lone, Hotel Grand Park Rovinj, Hotel Adriatic and many others, have established them as one of the key drivers in Croatian architecture. For Prostorija, 3LHD designed the Umomoku outdoor collection. The collection was initially designed for the luxury beach Mulini in Rovinj and subsequently redesigned for serial production.



Grupa

Grupa (Filip Despot, Ivana Pavić, Tihana Taraba) is a Croatian design studio and a lighting objects brand. Their products are distinguished by minimalism, functionality and flexibility to one's personal choice. For Prostorija, Grupa designed the Monk collection, 3angle sofa, Tinker easy chair, Piun chair and Shtef shelves.



Meike Harde

Meike Harde is a Cologne-based designer specialized in textile crafts. She is using her vastly amassed empirical knowledge to create unconventional upholstery designs. With traditional tailoring techniques and a focus on cleverly placed seams, simple but novel designs revel in the natural character of fabric. Her design for Prostorija includes the Impression collection.



Simon Morasi Piperčić

Founded in 2013, Simon Morasi Piperčić is a Zagreb-based industrial design agency working on various projects ranging from industrial and spatial design to site-specific installations, art direction and design consultancy. His work has been published in several renowned magazines (Dezeen, Domus, Frame, Hypebeast...) and exhibited worldwide. For Prostorija, he has designed the Strain collection, Rhomb collection and Convert modular system.



Neisako

Neisako is a small design practice focusing on innovative and inspiring product design solutions. Previously working as Redesign, from 2020 it operates under the new name — Neisako. Studio works in a wide variety of design fields mostly driven by investigation in deeper meaning of creation through language of geometry. For Prostorija, they have designed Up-Lift and Pil-low sofabeds, Kontrapunkt recliner and Simetria coat stand.



Lea Aviani

Lea Aviani is the founder of Projectum, her Split-based design studio. Her designs have been produced by several international companies, although most of her work focuses on interior design. In her designs, Lea Aviani tries to unite tradition and innovation, with the strong influence of the Mediterranean way of life.



Böttcher & Kayser

Moritz Böttcher and Sören Henssler founded their Berlin based design studio in 2007. In 2013 the designer Nikolaus Kayser joined the team. Since 2014 the trio is working under the studio name Böttcher Henssler Kayser in the fields of consumer product, furniture and lighting design with companies such as ANTA, Böwer, Mater, Normann Copenhagen, Scantex, Schönbuch, Vertigo Bird and Zero. The designers were honoured with a number of distinctions for Seam, their sofa produced by Prostorija.



Sanja Knezović

Sanja Knezović is primarily an architect who heads her own architectural studio specialized for designing private houses and smaller commercial buildings. She has transferred the experience gained from designing furniture units for interiors onto designing upholstered furniture for Prostorija, her first project in the field of product design. For Prostorija, Sanja Knezović designed the Match and Cloud sofa-beds.



Meike Harde

Meike Harde is a Cologne-based designer specialized in textile crafts. She is using her vastly amassed empirical knowledge to create unconventional upholstery designs. With traditional tailoring techniques and a focus on cleverly placed seams, simple but novel designs revel in the natural character of fabric. Her design for Prostorija includes the Impression collection.



Simon Morasi Piperčić

Founded in 2013, Simon Morasi Piperčić is a Zagreb-based industrial design agency working on various projects ranging from industrial and spatial design to site-specific installations, art direction and design consultancy. His work has been published in several renowned magazines (Dezeen, Domus, Frame, Hypebeast...) and exhibited worldwide. For Prostorija, he has designed the Strain collection, Rhomb collection and Convert modular system.



Neisako

Neisako is a small design practice focusing on innovative and inspiring product design solutions. Previously working as Redesign, from 2020 it operates under the new name — Neisako. Studio works in a wide variety of design fields mostly driven by investigation in deeper meaning of creation through language of geometry. For Prostorija, they have designed Up-Lift and Pil-low sofabeds, Kontrapunkt recliner and Simetria coat stand.



Filip Gordon Frank

Filip Gordon Frank is an industrial and interior designer with his own studio where he combines product and interior design. His company Polymorph manufactures the line of his own designs. For Prostorija, he has designed the Coo Coo birdhouse.



RU:T

Studio RU:T is a multidisciplinary design studio founded by Tvrtko Bojić and Karla Paliska specializing in product and industrial design, visual communications, spatial concepts and on-site interventions. In their work, they focus on practical and sustainable solutions as well as experiments that question the concept of living. For Prostorija, Studio RU:T designed the Knif shelving system.



Borovnjak & Bratović

Ivana Borovnjak and Roberta Bratović are product designers who work together on self-initiated projects in product design and visual communications. Apart from that, they work on projects in the fields of culture, art, theatre and nonprofit organisations from Amsterdam, London and Zagreb. For Prostorija, they designed the Revolve sofa-bed in collaboration with Numen / For Use.

Prostoria
Pustodol Začretski 19G
49223 Sv. Križ Začretje
Croatia

+385 49 200 555
info@prostoria.eu
www.prostoria.eu

Art Direction & Set Design
(Studio Interiors):
Grupa

Artworks in Studio Interiors:
Paintings by Julije Knifer
Sculptures by Vojin Bakić

Art Direction & Set Design
(Revisiting Architecture):
Biro Architects

Design & Art Direction
(Essence Sculptures):
Boir

Design:
Kurppa Hosk

Photography:
Marko Mihaljević
Jure Živković
Vanja Šolin
Domagoj Kunić
Matej Dokić
Davor Puklavec (Pixsell)
Željko Lukunić (Pixsell)
Damir Kovačić

Production:
Lunch

2021

This brochure is for informational purposes only and it is made in accordance with the information at the time of printing. Deviations of ± 3 cm in product dimensions are possible. We are not responsible for any printing errors, subsequent product changes or image fidelity. We kindly ask you to contact our authorised sales outlets for all queries regarding product characteristics and appearance, and any additional or new information required for reaching a final purchase decision.

All rights reserved. © 2021
Prostoria Ltd

